

National Aeronautics and Space Administration

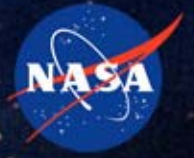

# STS-117

BUILDING ON  
EXPERIENCE



[www.nasa.gov](http://www.nasa.gov)





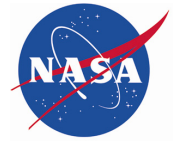

# CONTENTS

Section	Page
<b>STS-117 MISSION OVERVIEW</b> .....	<b>1</b>
<b>STS-117 TIMELINE OVERVIEW</b> .....	<b>11</b>
<b>MISSION PRIORITIES</b> .....	<b>13</b>
<b>LAUNCH AND LANDING</b> .....	<b>15</b>
<b>LAUNCH</b> .....	<b>15</b>
<b>ABORT-TO-ORBIT (ATO)</b> .....	<b>15</b>
<b>TRANSATLANTIC ABORT LANDING (TAL)</b> .....	<b>15</b>
<b>RETURN-TO-LAUNCH-SITE (RTL)</b> .....	<b>15</b>
<b>ABORT ONCE AROUND (AOA)</b> .....	<b>15</b>
<b>LANDING</b> .....	<b>15</b>
<b>MISSION PROFILE</b> .....	<b>17</b>
<b>STS-117 ATLANTIS CREW</b> .....	<b>19</b>
<b>MISSION PERSONNEL</b> .....	<b>29</b>
<b>KEY CONSOLE POSITIONS FOR STS-117</b> .....	<b>29</b>
<b>RENDEZVOUS AND DOCKING</b> .....	<b>31</b>
<b>SPACEWALKS</b> .....	<b>35</b>
<b>PAYLOAD OVERVIEW</b> .....	<b>43</b>
<b>INTEGRATED TRUSS SEGMENTS S3 AND S4</b> .....	<b>43</b>
<b>EXPERIMENTS</b> .....	<b>53</b>
<b>DETAILED TEST OBJECTIVES</b> .....	<b>53</b>
<b>SHORT-DURATION BIOASTRONAUTICS INVESTIGATION (SDBI)</b> .....	<b>53</b>
<b>SHORT-DURATION RESEARCH AND STATION EXPERIMENTS</b> .....	<b>54</b>
<b>EXTERNAL TANK ET-124 REPAIRS</b> .....	<b>57</b>
<b>SPACE SHUTTLE MAIN ENGINE ADVANCED HEALTH MANAGEMENT SYSTEM</b> .....	<b>63</b>

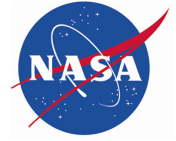

---

Section	Page
<b>SHUTTLE REFERENCE DATA .....</b>	<b>65</b>
<b>ACRONYMS AND ABBREVIATIONS .....</b>	<b>79</b>
<b>MEDIA ASSISTANCE .....</b>	<b>95</b>

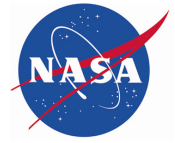

## MISSION OVERVIEW

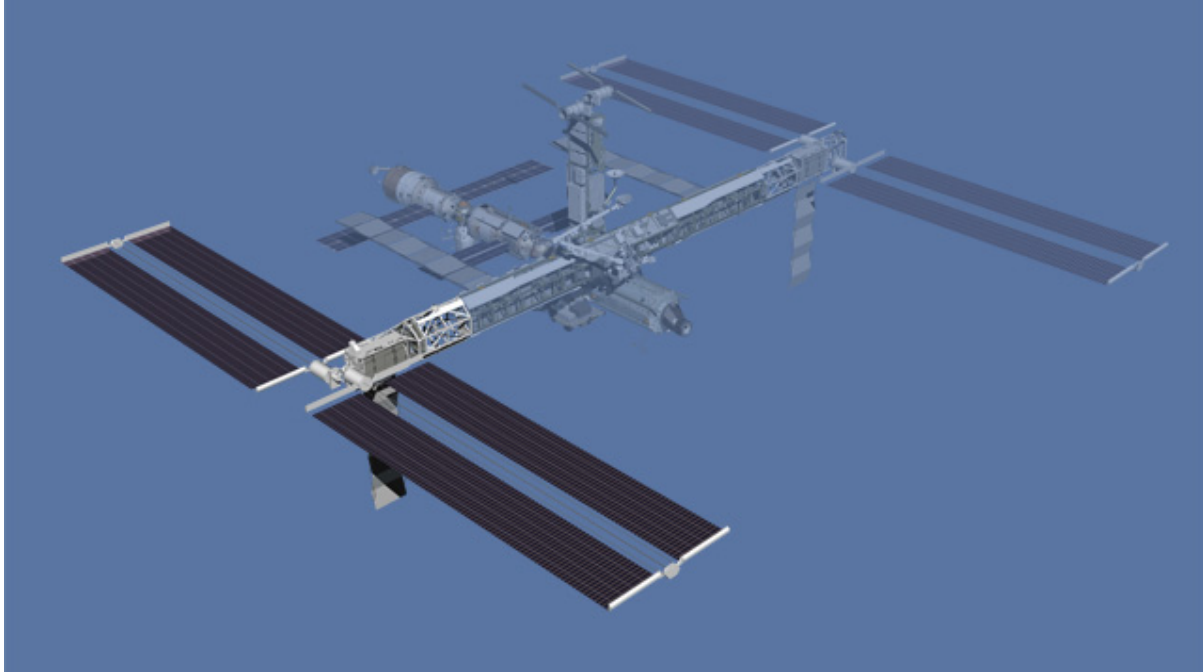

**A computer-generated artist's rendering of the International Space Station after flight STS-117/13A, following the delivery and installation of the second starboard truss segment (S3/S4), the deployment of the third set of solar arrays, and the retraction of the P6 starboard solar array wing and one radiator are retracted.**

The STS-117 mission continues construction of the International Space Station and incorporates lessons learned from the two most recent shuttle missions, STS-115 and STS-116. STS-117 will complete similar tasks such as installing new solar arrays and retracting an existing array. The ground control teams and spaceflight crews have used the past missions' experiences, both challenges and successes, as a guide for this next step in space station assembly.

Space shuttle Atlantis will launch seven astronauts for its 28th flight and the 118th shuttle mission. Rick Sturckow (STUR-coe), a Marine colonel, will command the flight. Pilot Lee Archambault (ARSH-um-boe), an Air Force colonel, joins Sturckow in the shuttle's cockpit. Mis-

sion specialists Patrick Forrester, Steven Swanson, John "Danny" Olivas (Oh-LEE-vuhs) and Jim Reilly will conduct the mission's three scheduled spacewalks.

After several months working aboard the station, NASA astronaut Sunita Williams will return to Earth aboard Atlantis. The flight will also carry her successor, astronaut Clayton Anderson, who arrives on Atlantis to begin his duty as an Expedition 15 flight engineer.

The exchange of Anderson and Williams was originally planned for the STS-118 mission, now targeted for launch in August. However, that flight, first set to fly in June, had to be postponed after an unexpected hail storm damaged Atlantis' external fuel tank and delayed STS-117.

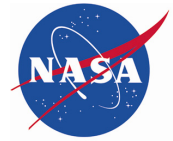

**While seated at the commander's station, astronaut Rick Sturckow, STS-117 commander, participates in a training session in the crew compartment trainer (CCT-2) in the Space Vehicle Mockup Facility at Johnson Space Center.**

With the new plan, Williams' mission on the station will be approximately the same length as originally anticipated. Williams, a Massachusetts native, launched to the station Dec. 9, 2006, aboard the space shuttle Discovery as part of the STS-116 mission. During her stay, she set a record for spacewalks by a female astronaut with a total of 29 hours and 17 minutes. Upon Williams' return, she will have accumulated more time in space than any other woman. STS-117 was deemed a space station crew rotation flight in April 2007.

The mission will deliver and install the 17.5-ton S3/S4 truss segment to the starboard side of the integrated truss system of the orbital outpost. The truss, part of the station's girder-like backbone, is a mirror image of the P3/P4 truss installed during STS-115 in September 2006.

The new truss segment includes a set of photovoltaic solar arrays. When unfurled, the 240-foot arrays provide additional power for the station in preparation for the delivery of international science modules during the next two years.

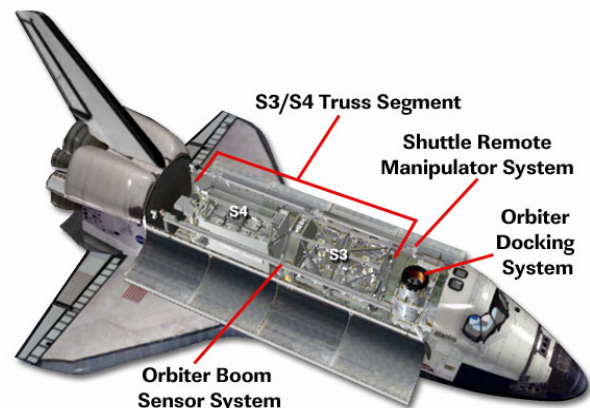

**This graphic depicts the key elements in Atlantis' payload bay for STS-117.**



**Astronaut Lee Archambault, STS-117 pilot, participates in a training session in the crew compartment trainer.**

Each of the 82 active array blankets that are grouped into 31.5 “bays” contains 16,400 silicon photovoltaic cells to convert sunlight into electricity. The truss also contains a Solar Alpha Rotary Joint (SARJ), which will rotate 360 degrees, clockwise or counterclockwise, to position the S4 and S6 solar arrays to track the sun.

Processes to activate the SARJ were modified after STS-115. During that mission, difficulties were encountered with software associated with the gears within the joint, and spacewalking astronauts had trouble loosening bolts during its structural preparation. Software to control the SARJ was updated, and the spacewalkers now will carry another tool, called a torque

multiplier, to help remove any balky launch restraints.

The mission includes the retraction of the starboard solar array, known as 2B, on the P6 truss atop the station, which would otherwise interfere with the rotation of the new starboard arrays. The retraction also prepares the P6 truss for its relocation to the outboard port side of the station later this year. Retraction will begin a day earlier than originally planned because of the tricky retraction of the P6 port side solar array during the STS-116 mission in December. Atlantis’ spacewalk teams are also prepared to assist the retraction.



**The rotating service structure on Launch Pad 39A has been fully opened for the first time in more than a year due to maintenance and upgrades on the pad. Pad 39A is ready for the STS-117 launch, the first at the pad in four years.**

Atlantis is targeted to lift off from Launch Pad 39A at NASA's Kennedy Space Center in Florida (on June 8 at approximately 7:38 p.m. EDT).

Atlantis' launch window will remain open until July 19 when the sun's beta angle at the station is unfavorable for a docked shuttle mission. STS-117 is expected to last at least 11 days with the scheduled spacewalks on flight days 4, 6 and 8.

The first three days of the mission closely mirror those of recent shuttle flights with inspection of thermal protection system tiles and wing leading edge reinforced carbon-carbon panels, and rendezvous and docking with the station.



**On flight day 2, an inspection of the thermal protection system will be performed.**





Astronauts Steven Swanson (center) and Lee Archambault (right), STS-117 mission specialist and pilot, respectively, participate in an exercise in the systems engineering simulator in the Jake Garn Simulation and Training Facility at Johnson Space Center. The facility includes moving scenes of full-sized International Space Station components over a simulated Earth.



Forrester is the prime shuttle robotic arm operator, working with Archambault and Olivas to inspect Atlantis using the arm extension, known as the Orbiter Boom Sensor System. Robotics teams have incorporated lessons from previous inspections to streamline the procedure, saving about one-and-a-half hours. The same inspections of the wings and other orbiter surfaces will take place after undocking from the station to check for any damage incurred during the mission.

When Atlantis arrives at the station two days after launch, the Expedition 15 Commander Fyodor Yurchikhin and flight engineers Oleg Kotov and Sunita Williams will greet the six-person shuttle crew. Yurchikhin and Kotov arrived at the complex April 9, following their April 7 launch on the Russian Soyuz spacecraft from the Baikonur Cosmodrome in Kazakhstan. They are scheduled to return to Earth in October after the arrival of the next station crew. Williams came to the station on Discovery's STS-116 flight in December. She will return at the end of STS-117 onboard Atlantis.



ISS015E08237

**Cosmonauts Fyodor N. Yurchikhin (left), Oleg V. Kotov (right), Expedition 15 commander and flight engineer, respectively, and astronaut Sunita L. Williams, flight engineer, photographed during a teleconference in the Zvezda Service Module of the International Space Station.**

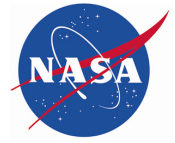

Once hatches are open, Forrester and Archambault will use the shuttle's robotic arm to grapple the S3/S4 truss. They will hand it off to the station's robotic arm being operated by Williams from the station's Destiny lab. The truss will remain grappled to the station's Canadarm2 overnight.

A customized seat liner will be installed in the station's Soyuz emergency return spacecraft for Anderson, signifying the beginning of his expedition onboard.

Reilly and Olivas will begin spacewalk preparations promptly. Spacewalkers will use the "campout" protocol, staying overnight in the Quest airlock to remove nitrogen from their bloodstreams. That will prevent a condition known as decompression sickness, commonly called the "bends."

The next morning, as Reilly and Olivas prepare to leave the Quest airlock for their first space-

walk of the mission, Archambault, Kotov and Forrester slowly and carefully will position the S3/S4 truss at the edge of the S1 truss for installation using the Canadarm 2. Once the truss is secured in place, the spacewalkers will make the wiring connections and prepare the new solar arrays and thermal radiator for deployment. The radiator will be deployed at the end of the spacewalk.

On flight day 5, the crew and ground control teams will work together to deploy the new solar arrays and transfer equipment and supplies between the shuttle and station. At the end of the day, the station's robotic arm will be maneuvered into position for the second spacewalk. While the crew sleeps, the ground control team will move the arm and its mobile work platform from work site No. 2 to work site No. 3 on the station's truss.



**Astronauts John "Danny" Olivas and Jim Reilly, both STS-117 mission specialists, are about to be submerged in the waters of the Neutral Buoyancy Laboratory (NBL) near Johnson Space Center.**

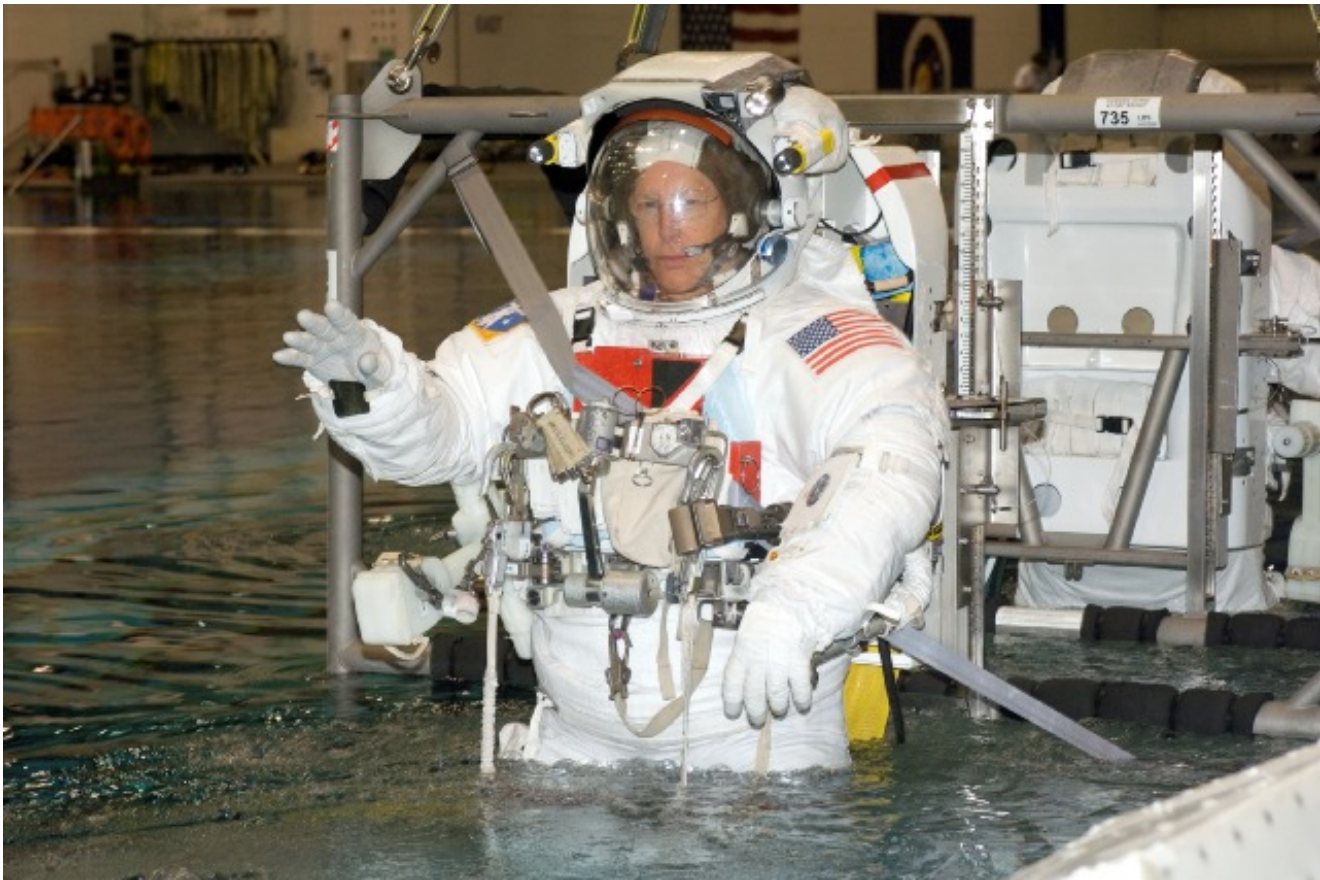
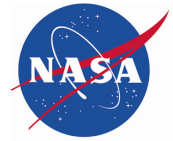

**Astronauts Patrick Forrester and Steven Swanson (partially obscured), both STS-117 mission specialists, are about to begin a spacewalk simulation in the NBL.**

Before the second spacewalk on flight day 6, the crew will begin retracting the P6 starboard solar array from inside the shuttle. They will command it to retract one bay at a time, starting with less than one bay at first, to bring the panels into their storage boxes. They will continue until only 19 of the 31.5 bays are extended. That will clear the area for the SARJ rotation, or until the crew needs to turn its focus to the spacewalk preparations.

If the solar array panels begin to hang up or fold incorrectly, as they did on STS-116, Forrester and Swanson could try to correct the issue at

the beginning of the spacewalk. They will carry the same tools wrapped with insulating tape and use the same techniques developed during STS-116.

The ground control team also can try to free guide wires stuck on grommets on the panels by commanding the array's Beta Gimbal Assembly (BGA) to rotate in one direction and then the other.

After spending some spacewalk time with the solar array retraction, if needed, the spacewalkers will continue releasing locks and restraints on the SARJ to allow its activation.

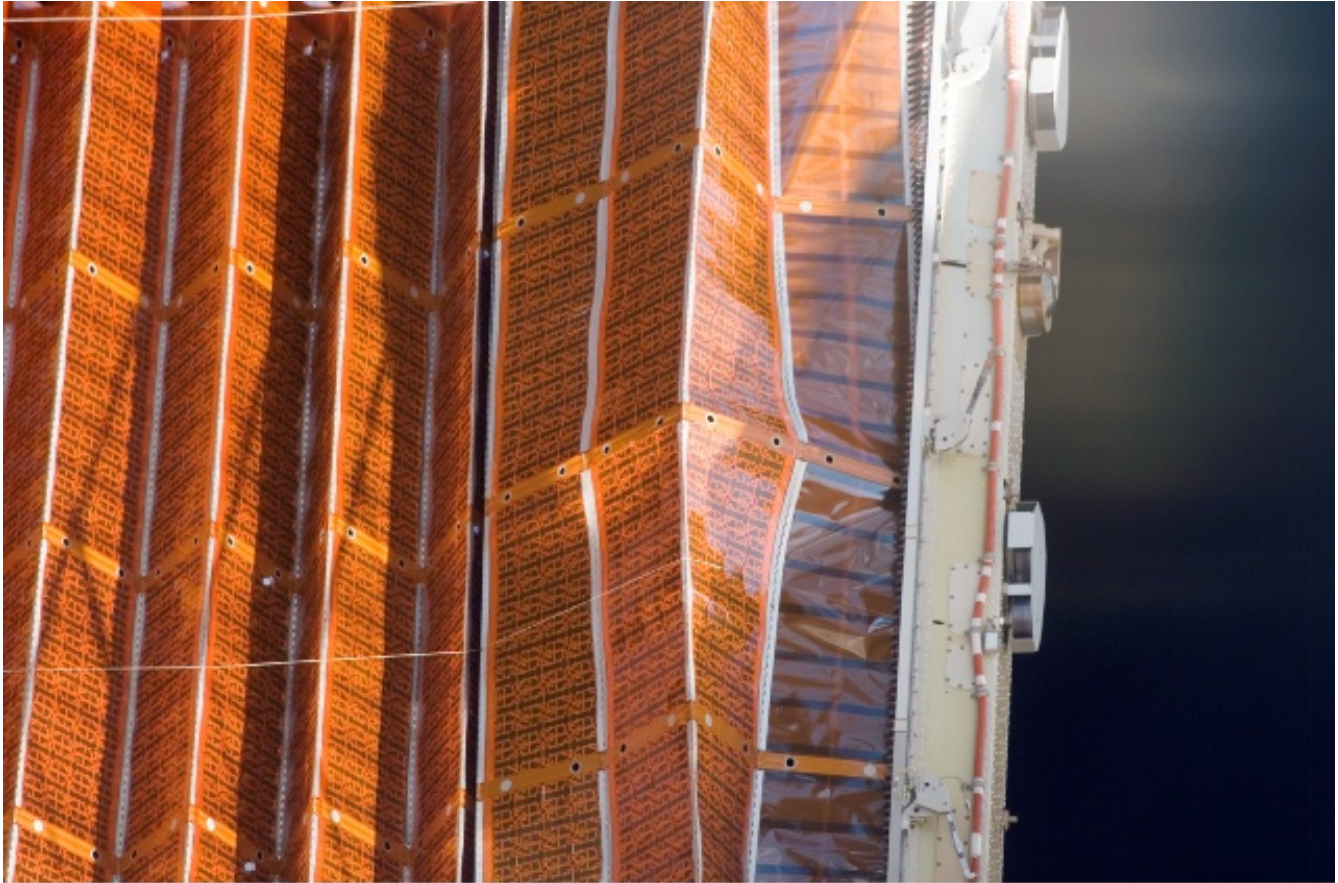

S116E05789

**This digital still image was taken by an STS-116 crew member aboard space shuttle Discovery of a kink that occurred in the port-side P6 solar array during the first attempt to retract that array on Dec. 13. The crew later extended the array and cleared this kink. The slow retraction of the array was done again with similar retraction and extension cycles repeated as the day progressed.**

If necessary, the crew will resume retraction of the P6 solar array on flight day 7. The final bays will be retracted carefully in a stepped fashion, stopping at one-half bay and one-quarter bay before fully retracting. If the retraction can not be completed on that day from inside the vehicles, the third spacewalk will be dedicated to fixing issues with the array retraction.

If a focused inspection of Atlantis' heat shield is requested once the shuttle is at the station, time would be made available for it on flight day 7. In this case, additional solar array retractions

would be conducted during spacewalk preparations on flight day 8 instead of flight day 7.

Reilly and Olivas' third spacewalk on flight day 8 is dedicated to maintenance and assembly tasks, unless they need to help with retracting the P6 solar array.

Flight day 9 includes off-duty time for the shuttle astronauts and final transfer of cargo between the two vehicles. The shuttle crew will say farewell to the Expedition 15 crew and close hatches at the end of the day.

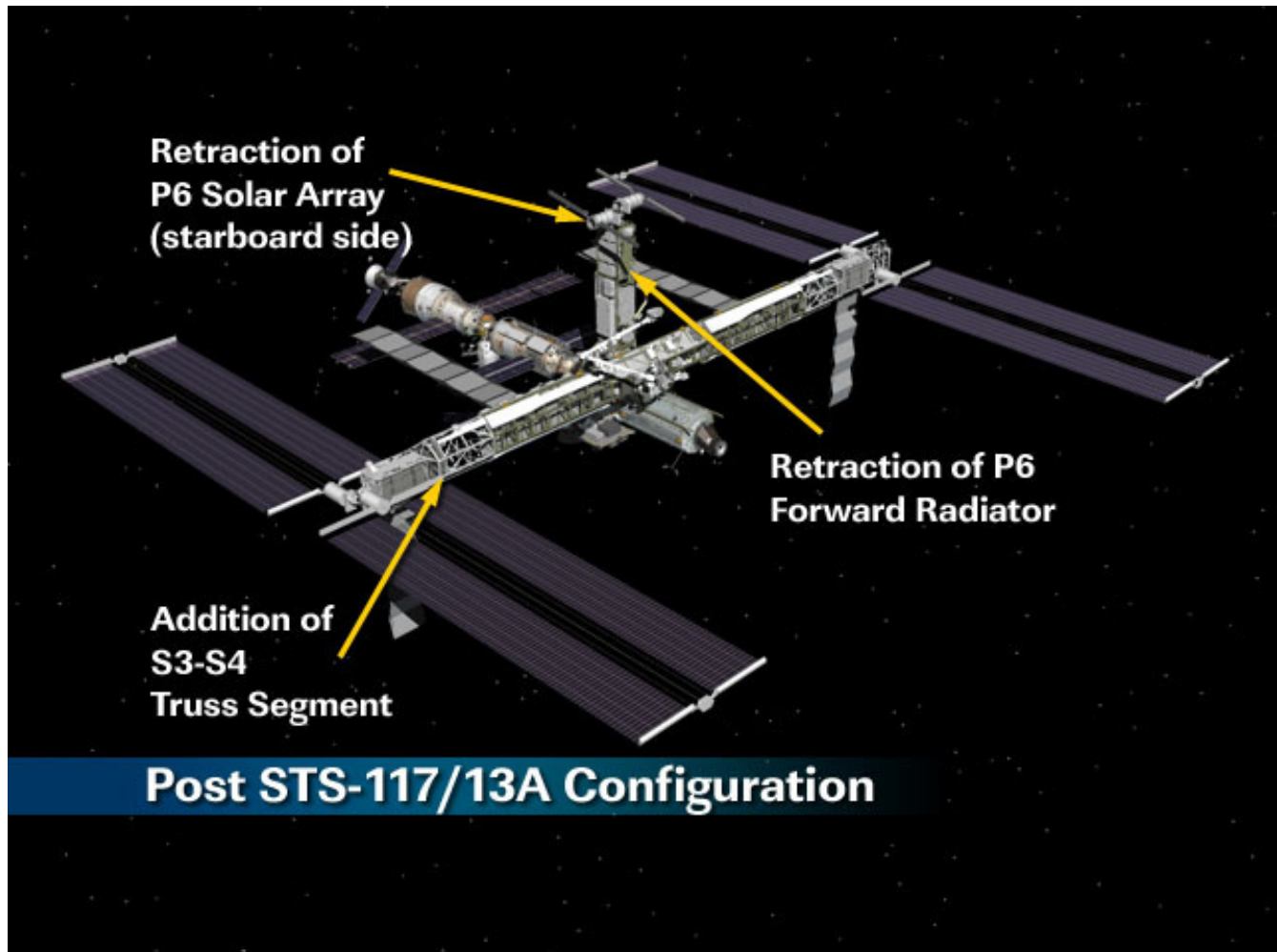
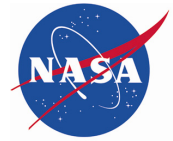

**The International Space Station as it will appear following the STS-117/ISS 13A mission.**

On flight day 10, undocking from the station is expected early in the crew's workday to allow for a fly around of the complex to document the station's new configuration. The flyaround also provides time to complete a final inspection of Atlantis' heat shield using the orbiter boom sensor system.

The astronauts will stow their gear, test Atlantis' flight control surfaces and steering jets and review their entry and landing procedures on flight day 11. Atlantis is scheduled to land on the morning of flight day 12, bringing the first shuttle mission of 2007 to a close.



## TIMELINE OVERVIEW

### FLIGHT DAY 1

- Launch
- Payload Bay Door Opening
- Ku-Band Antenna Deployment
- Shuttle Robot Arm Power Up
- External Tank Handheld Video, Umbilical Well Imagery and Wing Leading Edge Sensor Data Downlink

### FLIGHT DAY 2

- Shuttle Robot Arm Checkout
- Shuttle Robot Arm Grapple of Orbiter Boom Sensor System (OBSS)
- Inspection of Shuttle Thermal Protection System and Wing Leading Edge Reinforced Carbon-Carbon (RCC)
- OBSS Berthing
- Spacesuit Checkout
- Orbiter Docking System Outer Ring Extension
- Airlock Preparations
- Rendezvous Tool Checkout

### FLIGHT DAY 3

- Rendezvous Operations
- Terminal Initiation Engine Firing
- Rendezvous Pitch Maneuver and ISS Digital Photography of Atlantis

- Docking to the International Space Station
- Hatch Opening and Welcoming by Expedition 14 Crew
- Clay Anderson/Suni Williams Soyuz seatliner and crew exchange
- Shuttle robot arm grapple of S3/S4 truss and handoff to station robot arm for overnight parking
- Reilly and Olivas sleep in Quest Airlock for spacewalk pre-breathe campout protocol

### FLIGHT DAY 4

- Station robot arm installs S3/S4 truss on the S1 truss
- Reilly and Olivas EVA No. 1 to connect S1/S3 power cables, release launch restraints, release solar array blanket box restraints and install Solar Alpha Rotary Joint Drive Lock Assemblies
- S3 truss and S4 electrical channel 3A and 1A activation

### FLIGHT DAY 5

- S4 solar array deployment
- Solar Alpha Rotary Joint unlocking
- Forrester and Swanson sleep in Quest Airlock for spacewalk pre-breathe campout protocol

### FLIGHT DAY 6

- Initial attempt to retract P6 starboard array during EVA No. 2 preparations



- Forrester and Swanson EVA No. 2 to release Solar Alpha Rotary Joint locks and deploy braces in preparation for its initial rotation

## **FLIGHT DAY 7**

- Possible additional retraction of P6 starboard array to its full retracted position for blanket box latching
- Placeholder for focused inspection of Atlantis' thermal heat shield, if required
- Crew off-duty period
- Reilly and Olivas sleep in Quest Airlock for spacewalk pre-breathe campout protocol

## **FLIGHT DAY 8**

- ISS power down of electrical channels 1 and 4
- Reilly and Olivas EVA No. 3 to install an external hydrogen vent valve on the Destiny Laboratory for the new Oxygen Generation System and TBD tasks
- Space Station Remote Manipulator System moves from the Mobile Base System to Destiny Laboratory. The relocation is also known as a "walkoff"

## **FLIGHT DAY 9**

- Shuttle to ISS transfer work
- Crew off-duty period

- Crew News Conference
- Farewells and Hatch Closing
- Rendezvous tool checkout

## **FLIGHT DAY 10**

- Undocking and ISS flyaround
- Final separation from ISS
- Late inspection of Atlantis' thermal heat shield

## **FLIGHT DAY 11**

- Flight Control System Checkout
- Reaction Control System Hot-Fire Test
- Cabin Stowage
- Deorbit Timeline Review
- Ku-Band Antenna Stowage

## **FLIGHT DAY 12**

- Deorbit Preparations
- Payload Bay Door Closing
- Deorbit Burn
- KSC Landing





## MISSION PRIORITIES

1. Perform flight day 2 inspection, Rendezvous Pitch Maneuver, Thermal Protection System (TPS) tile inspection during rendezvous and docking using International Space Station (ISS) imagery, including focused and late inspection as required, and downlink all inspection data
2. Rotate Expedition 14 Flight Engineer 2 (Williams) with Expedition 15 Flight Engineer 2 (Anderson) and transfer mandatory crew rotation cargo per Flight 13A Transfer Priority List
3. Install Integrated Truss System (ITS) Starboard 3/Starboard 4 (S3/S4) onto ITS S1 and activate ITS S3/S4 systems to receive survival power from S1
4. Complete S3/S4 installation and activation
5. Transfer mandatory quantities of water from shuttle to the station
6. Transfer critical items
7. Configure and deploy the S4 Photovoltaic Radiator (PVR) and activate the Active Thermal System (ATS) thermal condition and boost charge the S4 Channel 1A and 3A batteries
8. Configure ISS and S4 element for S4 (Channel 1A and 3A) Solar Array Wing (SAW) deployments and deploy 1A and 3A SAWs
9. Reconfigure P6 for survival power and retract P6 starboard (Channel 2B) SAW
10. Configure and activate the starboard Solar Alpha Rotary Joint (SARJ)
11. Verify 1A and 3A SAW positioning to support docking and undocking operations for visiting vehicles (Alpha or Beta Joint)
12. Perform full rotation checkout of SARJ
13. Configure station for post S3/S4 installation
14. Remove and replace Synch Control Unit
15. Perform minimum crew handover of 12 hours per rotating crew member which includes crew safety handover
16. Transfer remaining items
17. Complete extravehicular activity (EVA) tasks to enable the mobile transporter (MT) to be moved to workstation No. 1 on the station's truss
18. Perform EVA task to modify existing lab condensate water vent to a hydrogen vent and open vent valve
19. Perform U.S. and Russian segment daily activities to support ISS powered payload daily status checks
20. Perform full-functional checkout of S3/Bay 2 MT workstation No. 1
21. Perform the following EVA tasks:
  - (a) Install Video System Stanchion Assembly (VSSA) stanchion on Camera Port 1
  - (b) Engage S4-S5 soft dock mechanism



- (c) Perform Rocketdyne Truss Attachment System (RTAS) visual inspection and Foreign Object Debris (FOD) check
  - (d) Position EVA aids and tools to support flight 13A.1
  - (e) Remove Handrail No. 120
  - (f) Relocate APFR No. 4
  - (g) Install S-Band Antenna Support Assembly launch lock bolts
  - (h) Inspect P6 PIP pin along translation path
  - (i) Route and install Node 1/PMA 1 LAN Cable
  - (j) Install External Wireless Instrumentation System (EWIS) antenna
  - (k) Remove and return GPS Antenna No. 4
  - (l) Release S4 IEA Micrometeoroid (MMOD) debris shield fasteners
  - (m) Deploy S3 LO Payload Attachment Site (PAS)
  - (n) Install S1-S3 ammonia fluid lines
  - (o) Install SASA launch locks.
  - (p) Install VSSA stanchion on Camera Port 7
22. Transfer oxygen from the shuttle to the station's high-pressure gas tank if shuttle margins permit
23. Internal Thermal Control System (ITCS) coolant remediation
24. Perform payload research operations tasks
25. Perform the following utilization activities:
- (a) Perceptual Motor Deficits In Space on ISS if crew time available
  - (b) Short Duration Bioastronautics Investigations (SDBI)1503-S, Midodrine
  - (c) Maui Analysis of Upper-Atmospheric Injections (MAUI) operations payload of opportunity if propellant and timeline are available
  - (d) Ram Burn Observation (RAMBO) payload operations (payload of opportunity with no hardware or dedicated OMS burns)
26. Perform imagery survey of the station's exterior during shuttle fly around after undock, if propellant available
27. Perform Station Development Test Objective (SDTO) 13005-U, Structural Life Validation and Extension for Dedicated Thruster Firing (Integrated Wireless Instrumentation System, or IWIS, required)
28. Perform SDTO 12004-U, Shuttle Booster Fan Bypass for Shuttle Docked Operations
29. Perform SDTO 13005-U, Structural Life Validation and Extension for S3/S4 installation, IWIS required
30. Perform SDTO 15003-U, Microgravity Environment Definition, for Orbiter Ergometer Exercise, IWIS required
31. Perform SDTO 15003-U, Microgravity Environment Definition, for SARJ checkout



## **LAUNCH AND LANDING**

### **LAUNCH**

As with all previous space shuttle launches, Atlantis has several options to abort its ascent if needed due to engine failures or other systems problems. Shuttle launch abort philosophy aims toward safe recovery of the flight crew and intact recovery of the orbiter and its payload.

Abort modes include:

#### **ABORT-TO-ORBIT (ATO)**

This mode is used if there is partial loss of main engine thrust late enough to permit reaching a minimal 105 by 85 nautical mile orbit with the orbital maneuvering system engines. The engines boost the shuttle to a safe orbital altitude when it is impossible to reach the planned orbital altitude.

#### **TRANSATLANTIC ABORT LANDING (TAL)**

The loss of one or more main engines midway through powered flight would force a landing at either Zaragoza, Spain; Moron, Spain; or Istres, France. For launch to proceed, weather conditions must be acceptable at one of these TAL sites.

### **RETURN-TO-LAUNCH-SITE (RTL)**

If one or more engines shuts down early and if there is not enough energy to reach Zaragoza, the shuttle would pitch around toward KSC until within gliding distance of the Shuttle Landing Facility. For launch to proceed, weather conditions must be forecast to be acceptable for a possible RTL landing at KSC about 20 minutes after liftoff.

#### **ABORT ONCE AROUND (AOA)**

An AOA is selected if the vehicle cannot achieve a viable orbit or will not have enough propellant to perform a deorbit burn but has enough energy to circle the Earth once and land about 90 minutes after liftoff.

### **LANDING**

The primary landing site for Atlantis on STS-117 is the Kennedy Space Center's Shuttle Landing Facility. Alternate landing sites that could be used if needed due to weather conditions or systems failures are at Edwards Air Force Base, Calif., and White Sands Space Harbor, N.M.

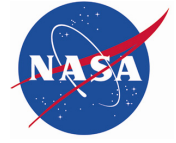

This page intentionally left blank.



# MISSION PROFILE

## CREW

<b>Commander:</b>	Rick Sturckow
<b>Pilot:</b>	Lee Archambault
<b>Mission Specialist 1:</b>	Patrick Forrester
<b>Mission Specialist 2:</b>	Steven Swanson
<b>Mission Specialist 3:</b>	John "Danny" Olivas
<b>Mission Specialist 4:</b>	Jim Reilly
<b>Mission Specialist 5:</b>	Clayton Anderson (Up)/Sunita Williams (Down)

## LAUNCH

<b>Orbiter:</b>	Atlantis (OV-104)
<b>Launch Site:</b>	Kennedy Space Center Launch Pad 39A
<b>Launch Date:</b>	No earlier than June 8, 2007
<b>Launch Time:</b>	7:38 p.m. EDT (Preferred In-Plane launch time for 6/8)
<b>Launch Window:</b>	5 Minutes
<b>Altitude:</b>	122 Nautical Miles (140 Miles) Orbital Insertion; 181 NM (208 Miles) Rendezvous
<b>Inclination:</b>	51.6 Degrees
<b>Duration:</b>	10 Days, 19 Hours, 9 Minutes

## VEHICLE DATA

<b>Shuttle Liftoff Weight:</b>	4,525,471 pounds
<b>Orbiter/Payload Liftoff Weight:</b>	270,469 pounds
<b>Orbiter/Payload Landing Weight:</b>	199,501 pounds
<b>Software Version:</b>	OI-30

## Space Shuttle Main Engines:

<b>SSME 1:</b>	2059
<b>SSME 2:</b>	2052
<b>SSME 3:</b>	2057
<b>External Tank:</b>	ET-124
<b>SRB Set:</b>	BI-129
<b>RSRM Set:</b>	96

## SHUTTLE ABORTS

### Abort Landing Sites

<b>RTLS:</b>	Kennedy Space Center Shuttle Landing Facility
<b>TAL:</b>	Primary – Zaragoza, Spain. Alternates – Moron, Spain (after June 15) and Istres, France
<b>AOA:</b>	Primary – Kennedy Space Center Shuttle Landing Facility; Alternate – White Sands Space Harbor

### Landing

<b>Landing Date:</b>	No earlier than June 19, 2007
<b>Landing Time:</b>	2:46 p.m. EDT
<b>Primary landing Site:</b>	Kennedy Space Center Shuttle Landing Facility

## PAYLOADS

Integrated Truss Segment (ITS) -  
Starboard 3/Starboard 4 (S3/S4)



This page intentionally left blank.



## STS-117 ATLANTIS CREW



The STS-117 crew patch symbolizes the continued construction of the International Space Station (ISS) and our ongoing human presence in space. The ISS is shown orbiting high above the Earth. The crew will install the portion of the station that is highlighted in gold. It consists of the second and third starboard truss sections, S3/S4, and a set of solar arrays. The names of the STS-117 crew are above and below the or-

biting outpost. The two gold astronaut office symbols, emanating from the "117" at the bottom of the patch, represent the concerted efforts of the shuttle and station programs to complete the station. The shuttle and unfurled banner of red, white and blue represent our nation's renewed patriotism as NASA continues to explore the universe.



Scheduled to launch aboard the space shuttle Atlantis are (from the left) Clayton Anderson, Jim Reilly, Steven Swanson, mission specialists; Rick Sturckow, commander; Lee Archambault, pilot; Patrick Forrester and John "Danny" Olivas, mission specialists. The crew members

are attired in training versions of their shuttle launch and entry suits.

Short biographical sketches of the crew with detailed background are available at:

<http://www.jsc.nasa.gov/Bios/>





**Rick Sturckow**

A Marine colonel, Rick Sturckow will lead the crew of STS-117 on the 21st shuttle mission to the space station. Sturckow served as the pilot of STS-88 in 1998 and STS-105 in 2001. Making his third spaceflight, he has logged more than 568 hours in space. He has overall responsibility for the execution of the mission, orbiter systems operations and flight operations, includ-

ing landing. In addition, Sturckow will fly the shuttle in a procedure called the rendezvous pitch maneuver while Atlantis is 600 feet below the station to enable the station crew to photograph the shuttle's heat shield. He will then dock Atlantis to the station. Sturckow also will be involved in photo documentation of various activities including the spacewalks.



**Lee Archambault**

An Air Force colonel, Lee Archambault has logged more than 4,000 hours flying more than 30 aircraft. He will make his first journey into space as the pilot for the STS-117 mission. Selected by NASA in June 1998, Archambault reported to the Johnson Space Center in Houston in August 1998. He has supported launch and landing operations at the Kennedy Space Center and served as a CAPCOM (capsule communicator) during the STS-121 shuttle mission. He

will be responsible for orbiter systems operations and will help Sturckow in the rendezvous and docking with the station. Archambault will be heavily involved in robotic arm operations during inspection of Atlantis' heat shield and will be the lead station robotic arm operator during the truss installation and spacewalks. He will undock Atlantis from the station at the end of the mission.



**Patrick Forrester**

A retired Army colonel, Mission Specialist 1 Patrick Forrester, is making his second spaceflight on STS-117. He flew on STS-105 in 2001 and completed two spacewalks totaling 11 hours and 45 minutes. Forrester will conduct the second of three spacewalks during the mission to prepare the truss and solar arrays for

tracking the sun to generate power. He will serve as the intravehicular coordinator of the other two spacewalks. Forrester is the prime shuttle robotic arm operator and will lead the inspection effort using its extension known as the Orbiter Boom Sensor System.



**Steven Swanson**

A member of the 1998 astronaut class, Mission Specialist 2 Steven Swanson will be making his first trip into space. He will do the second of three spacewalks during STS-117 and will be a robotic arm operator. He will be on the flight deck during launch and landing, serving as the flight engineer to assist Sturckow and Archambault. Swanson received a bachelor's from the

University of Colorado, a master's from Florida Atlantic University and a doctorate from Texas A&M University. He joined NASA as a systems engineer working on the shuttle training aircraft in 1987. He began training as an astronaut in August 1998, has worked in the Astronaut Office Space Station Operations and Robotics Branches and served as a CAPCOM.



**John "Danny" Olivas**

Mission Specialist 3 John "Danny" Olivas will be making his first flight into space and will conduct the first and third spacewalks of STS-117 to prepare the truss and solar arrays for tracking the sun to generate power. He will operate the shuttle robotic arm and its extended sensor boom to inspect Atlantis' heat shield. Olivas was a program manager at the Jet Pro-

pulsion Laboratory before being selected as an astronaut in 1998. He has worked in the Astronaut Office Robotics and Extravehicular Activity, or spacewalk, Branches. He received a bachelor's from the University of Texas-El Paso, a master's from the University of Houston and a doctorate from Rice University.



### **Jim Reilly**

A veteran of two spaceflights, Mission Specialist 4 Jim Reilly will conduct two of the three spacewalks during STS-117. He also will serve as the intravehicular coordinator of the second spacewalk. Reilly was selected as an astronaut

in 1994. He flew on STS-89 to the Russian Mir Space Station in 1998 and STS-104 to the International Space Station in 2001. Reilly has logged more than 517 hours in space, including three spacewalks totaling 16 hours and 30 minutes.



**Astronaut Clayton C. Anderson, mission specialist**

Replacing Williams as an Expedition 15 flight engineer, Anderson will join the crew during the STS-117 shuttle mission. Anderson is a graduate of Hastings College in Nebraska and Iowa State University. He joined NASA in 1983 in the Mission Planning and Analysis Division, before moving on to the Mission Operations

Directorate where he progressed to chief of the Flight Design Branch. He was selected to join NASA's astronaut corps in 1998. He most recently was back-up flight engineer for Expeditions 12, 13 and 14 to the station. He is scheduled to return to Earth on shuttle mission STS-120 in October.



**Astronaut Sunita L. Williams**

Williams, who arrived on the space station in December 2006 on shuttle Discovery during the STS-116 mission, will return to Earth via the space shuttle Atlantis on the STS-117 mission. Although this is her first spaceflight mission, Williams holds the spacewalk duration world record for females with a total extravehicular activity time of 29 hour, 17 minutes over four spacewalks. Her first spacewalk was with veteran spacewalker Bob Curbeam during STS-116. The other three spacewalks were con-

ducted with Expedition 14 Commander Michael Lopez-Alegria. Williams was selected by NASA in June 1998. She worked in Moscow with Russian space officials on Russian segment systems development for the station and with the first Expedition crew to the station. Williams will wrap up her long-duration spaceflight midway through Expedition 15. Upon her return, she will have accumulated more time in space than any other woman.





## MISSION PERSONNEL

### KEY CONSOLE POSITIONS FOR STS-117

	<u>Flt. Director</u>	<u>CAPCOM</u>	<u>PAO</u>
<b>Ascent</b>	Norm Knight	Tony Antonelli Terry Virts (Weather)	Kyle Herring
<b>Orbit 1 (Lead)</b>	Cathy Koerner	Terry Virts	Kylie Clem (Lead)
<b>Orbit 2</b>	Bryan Lunney	Kevin Ford	Kelly Humphries
<b>Planning</b>	Richard Jones	Shane Kimbrough	Pat Ryan
<b>Entry</b>	Norm Knight	Tony Antonelli Terry Virts (Weather)	Kylie Clem
<b>Shuttle Team 4</b>	Mike Sarafin	N/A	N/A
<b>ISS Orbit 1</b>	Annette Hasbrook	Steve Bowen	N/A
<b>ISS Orbit 2 (Lead)</b>	Kelly Beck	Megan McArthur	N/A
<b>ISS Orbit 3</b>	Holly Ridings	Rick Davis	N/A
<b>Station Team 4</b>	Sally Davis	N/A	N/A

**JSC PAO Representative at KSC for Launch** – Nicole Cloutier-Lemasters

**KSC Launch Commentator** – George Diller

**KSC Launch Director** – Mike Leinbach

**NASA Launch Test Director** – Steve Payne



This page intentionally left blank.

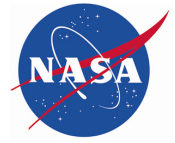

## RENDEZVOUS AND DOCKING



ISS014E08232

**This view of the nose and part of the crew cabin of Space Shuttle Discovery was provided by an Expedition 14 crewmember during a back-flip performed by the approaching STS-116 crew to the International Space Station.**

The shuttle launch is timed precisely to place the orbiter on the correct trajectory and course for its two-day chase of the station. Periodic engine firings will gradually bring Atlantis to about 50,000 feet behind the station—the starting point for a final approach.

About 2.5 hours before docking, Atlantis' jets will be fired during what is called the Terminal Initiation burn to begin the final phase of the rendezvous. Atlantis will close the final miles to the station during the next orbit.

As Atlantis moves closer to the station, the shuttle's rendezvous radar system and trajectory control sensor will track the complex and provide range and closing rate data to the crew. During the final approach, Atlantis will execute several small mid-course correction burns that will place Atlantis about 1,000 feet directly below the station. STS-117 Commander Rick Sturckow then will manually control the shuttle for the remainder of the approach and docking.

### Rendezvous Approach Profile

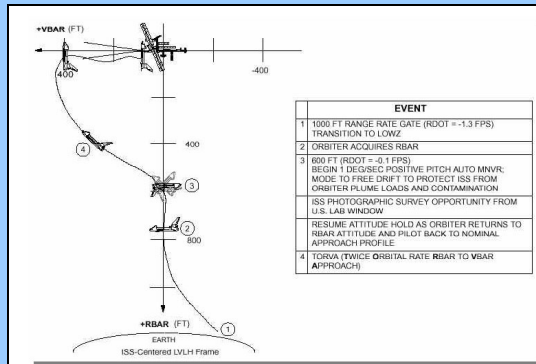

### Space Shuttle Rendezvous Maneuvers

**OMS-1 (Orbit insertion)** - Rarely used ascent burn.

**OMS-2 (Orbit insertion)** - Typically used to circularize the initial orbit following ascent, completing orbital insertion. For ground-up rendezvous flights, also considered a rendezvous phasing burn.

**NC (Rendezvous phasing)** - Performed to hit a range relative to the target at a future time.

**NH (Rendezvous height adjust)** - Performed to hit a delta-height relative to the target at a future time.

**NPC (Rendezvous plane change)** - Performed to remove planar errors relative to the target at a future time.

**NCC (Rendezvous corrective combination)** - First on-board targeted burn in the rendezvous sequence. Using star tracker data, it is performed to remove phasing and height errors relative to the target at Ti.

**Ti (Rendezvous terminal intercept)** - Second on-board targeted burn in the rendezvous sequence. Using primarily rendezvous radar data, it places the orbiter on a trajectory to intercept the target in one orbit.

**MC-1, MC-2, MC-3, MC-4 (Rendezvous midcourse burns)** - These on-board targeted burns use star tracker and rendezvous radar data to correct the post Ti trajectory in preparation for the final, manual proximity operations phase.

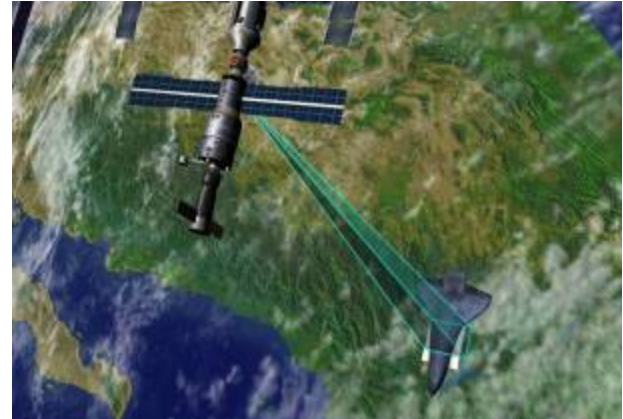

Imagery using 400 and 800 mm digital camera lenses will photograph Atlantis during the Rendezvous Pitch Maneuver.

He will stop the approach 600 feet beneath the station to ensure proper lighting for imagery prior to initiating the standard Rendezvous Pitch Maneuver (RPM), or backflip.

Sturckow will maneuver Atlantis through a 9 minute, 360-degree backflip that allows the station crew to take as many as 300 digital pictures of the shuttle's heat shield.

On verbal cue from Pilot Lee Archambault to the station crew, Sturckow will command Atlantis to begin a nose-forward, three-quarter of a degree per second rotational backflip.

The photos will be taken out of windows in the Zvezda Service Module with Kodak DCS 760 digital cameras outfitted with 400 mm and 800 mm lenses. The imagery is one of several inspection techniques to determine the health of the shuttle's thermal protection system, including the tiles and reinforced carbon-carbon wing leading edges and noscap.

The photos will be downlinked through the station's Ku-band communications system for analysis by systems engineers and mission managers.



When Atlantis completes its rotation, its payload bay will be facing the station. Sturckow then will move Atlantis to a position about 400 feet directly in front of the station in preparation for the final approach to docking to the Destiny docking port.

The shuttle's crew members operate laptop computers processing the navigational data, the laser range systems and Atlantis' docking mechanism.

Using a view from a camera mounted in the center of the Orbiter Docking System, Sturckow will precisely match up the docking ports of the two spacecraft. If necessary, he will temporarily pause 30 feet from the station to ensure proper alignment of the docking mechanisms.

For Atlantis' docking, Sturckow will maintain the shuttle's speed relative to the station at about one-tenth of a foot per second (while both Atlantis and the station are traveling at about 17,500 mph), and keep the docking mechanisms aligned to within a tolerance of three inches. When Atlantis makes contact with the station, preliminary latches will automatically attach the two spacecraft. Immediately after Atlantis docks, the shuttle's steering jets will be deactivated to reduce the forces acting at the docking interface. Shock absorber springs in the docking mechanism will dampen any relative motion between the shuttle and the station.

Once the motion between the spacecraft has been stopped, the docking ring will be retracted to close a final set of latches between the two vehicles.

## **UNDOCKING, SEPARATION AND DEPARTURE**

At undocking time, the hooks and latches will be opened, and springs will push the shuttle away from the station. Atlantis' steering jets will be shut off to avoid any inadvertent firings during the initial separation.

Once Atlantis is about two feet from the station and the docking devices are clear of one another, Archambault will turn the steering jets back on and will manually control Atlantis within a tight corridor as the shuttle separates from the station.

Atlantis will move to a distance of about 450 feet, where Archambault will begin to fly around the station in its new configuration. This maneuver will occur only if propellant margins and mission timeline activities permit.

Once Atlantis completes 1.5 revolutions of the complex, Archambault will fire Atlantis' jets to leave the area. The shuttle will move about 46 miles from the station and remain there while ground teams analyze data from the late inspection of the shuttle's heat shield. The distance is close enough to allow the shuttle to return to the station in the unlikely event that the heat shield is damaged, preventing the shuttle's re-entry.



S116E07154

Backdropped by the blackness of space, clouds and Earth's horizon, the International Space Station is seen as it and Space Shuttle Discovery begin their relative separation on Dec. 19, 2006.



## SPACEWALKS

The primary focus for STS-117's spacewalks, or extravehicular activities (EVAs), is to install the S3/S4 truss segment to the starboard side of the integrated truss system. The task is similar to that of the STS-115 mission, where the sister P3/P4 segment was installed.

The spacewalks also include assembly and maintenance tasks and could involve helping with the retraction of the P6 starboard solar array. Three spacewalks are planned on flight days 4, 6 and 8. Each spacewalk is estimated to last 6.5 hours.

Mission specialists Jim Reilly and John "Danny" Olivas will conduct the first and third spacewalks. Mission specialists Patrick Forrester and Steven Swanson will conduct the second. This will be Reilly's third spacewalk and Forrester's second. Olivas and Swanson will be conducting their first spacewalks.

Williams will assist with preparations in the airlock before each spacewalk. The spacewalkers will be identifiable by various markings on their spacesuits. Reilly will wear one with solid red stripes, while Olivas's suit will be solid white. Forrester will wear a suit with red, broken stripes, and Swanson will have a suit with diagonal, or candy cane-like, red stripes.

The spacewalks will start from the station's Quest airlock. Before each spacewalk, the astronauts will use the "campout" pre-breathe protocol, where they will spend the night in the airlock. This reduces the amount of time typically required for the pre-breathe exercise and, in some cases, the complexity of the next morning's spacewalk preparations.



**Astronaut Jim Reilly, STS-117 mission specialist, attired in a training version of the Extravehicular Mobility Unit (EMU) spacesuit, is about to begin a training session in the waters of the Neutral Buoyancy Laboratory (NBL) near the Johnson Space Center.**



As a result, the crew can get outside earlier to perform the day's tasks.

The crew members isolate themselves in the airlock. The airlock's air pressure is lowered to 10.2 psi, while the station is kept at 14.7 psi, or near sea-level pressure. Astronauts aboard the shuttle perform a similar procedure for the shuttle-based spacewalks, lowering the entire spacecraft's air pressure a day or so beforehand.

The morning of the first spacewalk, the Integrated Truss Segment (ITS) S3/S4 will be attached to the Starboard 1 (S1) segment. The S3 segment consists of the S3 truss and Solar Alpha Rotary Joint (SARJ), a device that will rotate 360 degrees clockwise and counterclockwise to position the solar arrays to track the sun for electrical power. The S4 segment provides the station with a third set of photovoltaic Solar Array Wings (SAWs) that will provide additional power for the station once unfurled to their full length of 240 feet.

The station eventually will have 11 integrated truss segments that stretch 356 feet from end to end. They will support four virtually identical solar array assemblies that provide electrical power. They also will support radiators that will cool the station.

Major S3 subsystems include the Segment-to-Segment Attach System, SARJ and Unpressurized Cargo Carrier Attach System. Major S4 subsystems include the Photovoltaic Module, Photovoltaic Radiator (PVR) and Modified Rocketdyne Truss Attachment System.

The maintenance and assembly tasks include installing a vent on the Destiny lab for the future oxygen generation system, an External Wireless Instrumentation System (EWIS) antenna and routing cables on the Unity Node and Zvezda Service Module.

## EVA 1

The S3/S4 activation is complex and challenging for both the crew and the ground teams. It involves detailed sequential task choreography, cooperation between the intravehicular and extravehicular crew members and multiple Mission Control systems disciplines. During the first spacewalk, the crew will prepare the truss for activation and the solar arrays for deployment.

As Reilly and Olivas prepare for the spacewalk, Lee Archambault, station resident Oleg Kotov and Forrester will use the station's robotic arm to slowly move the 17.5 ton S3/S4 truss to the starboard side of the integrated truss system, aligning it using a television camera, then mating it to S1.

Once Reilly and Olivas leave the airlock, they will move to the newly installed truss. On a "go" from Mission Control once the proper electrical inhibits are in place, Reilly will connect power cables in the S1 to S3 lower utility tray, where the electrical connections are housed. Then Reilly will give the ground control team the clear to begin activation of the S3/S4 truss.

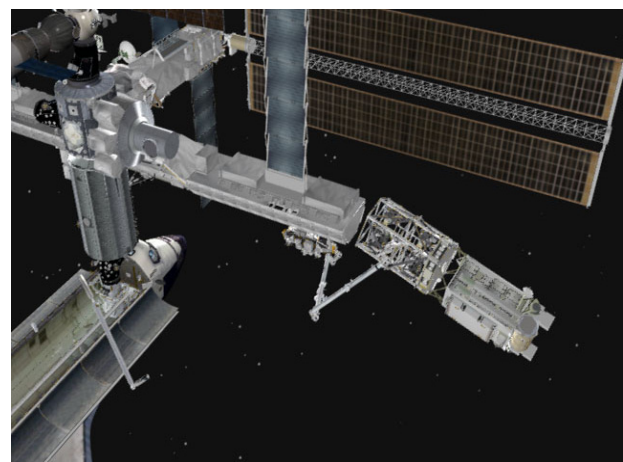

**The S3/S4 truss is positioned for installation.**





**STS-117 mission specialist John “Danny” Olivas prepares to train for his spacewalks at the NBL.**

He will then relocate a foot restraint, configure a tool and hardware bag for a later truss preparation task and remove a thermal shroud from a computer in the S3 truss. Afterward, Reilly will move to the upper utility tray on S3/S4 and repeat the choreography with Mission Control to continue the connections and activation of the truss.

Reilly will continue work on the truss. He will rotate a keel pin that held the S4 truss segment in place for launch and release launch restraints for the Beta Gimbal Assemblies (BGAs). The BGAs are the structural link between the truss' integrated electronics and the SAWs. Reilly will release both the forward and aft wing BGAs.

Olivas also will be working on the S3/S4 truss. His first task will be to release the aft and forward Solar Array Blanket Box (SABB) launch restraints, unbolting the SABBs from the Integrated Equipment Assembly. The SABBs hold the folded solar arrays.

Olivas will prepare the S4 PVR for deployment by removing cinches and winches on it. These must be released before the crew inside the station can deploy the radiator. The cinches are wire braided cables with nut assemblies on the end that serve as launch restraints for the PVR. Olivas will use a pistol grip tool (PGT) on the nuts to release the tension in the cable, remove the cable nut assembly from its receptacle on the PVR and attach the cinch to a clip on the PVR base plate.



The next task will be to release the winch bar, which secures the PVR during launch, from the PVR. A pip pin secures the winch bar to the outermost PVR panel. After the winch bar is released, the pip pin will be reinstalled into the winch bar. The radiator will then be ready for deployment at the end of the spacewalk.

Olivas next will begin preparing the SARJ for activation. He will deploy and rigidize the four Alpha Joint Interface Structure (AJIS) struts. The AJIS struts must be rigidized for purposes of structural loading prior to removing any of the launch locks later in the spacewalk.

The two spacewalkers then will work near each other while Reilly unstows the forward SABB

and Olivas unstows the aft SABB, the final step in preparing the solar arrays for deployment the next day.

Reilly then moves to another task to prepare the SARJ for activation. He will install two of four drive lock assemblies (DLAs). The other two DLAs will be installed on the second spacewalk. The drive lock assemblies must be deployed to provide a method of controlling the SARJ rotation.

At this time, Olivas will be removing thermal shrouds from forward and aft Sequential Shunt Units (SSU) and Electronics/environmental Control Units (ECU). Olivas will continue working with the AJIS strut installation as well.



**STS-117 underwater training activities are visible on the monitors in the simulation control area in the NBL. The STS-117 crew uses the NBL to rehearse both assigned and contingency spacewalks for its mission.**



The two spacewalkers will join each other again to remove launch locks simultaneously from the SARJ for the final task of the spacewalk. Most of the lock and restraint removal will be completed on the second spacewalk. Reilly and Olivas have time to begin the work by removing three launch locks each. There are 16 launch locks and 10 outer launch restraints. The launch locks and launch restraints constrain the SARJ and handle loads during ascent. All of the launch locks must be removed before any of the launch restraints can be removed.

Each launch lock is under a separate insulation cover that is in turn connected to the SARJ inboard bulkhead by four to six bolts and connected to the outboard bulkhead by one to three spring-loaded clamp bolts. After removing the cover, the launch lock is removed by releasing four bolts. Once the launch lock is removed, the cover is replaced and reattached to the SARJ inboard bulkhead. The outboard spring clamp bolts are left open to allow for SARJ rotation.

As the spacewalkers clean up and prepare to come back inside, Archambault and Swanson will command the radiator to deploy from inside the spacecraft. After the spacewalk, Mission Control Houston will command the activation of the S4 truss to check out its systems and the still folded solar arrays.

## **EVA 2**

Before the second spacewalk begins on flight day 6, the shuttle and station crew members will begin retracting the P6 starboard solar array. They will command it to retract one bay at a time, starting with less than one bay to bring the panels into their storage boxes. They will continue until only 19 of the 31.5 bays are ex-

tended, which clears the area for the SARJ rotation, or until the crew needs to turn its focus to the spacewalk preparations.

If the solar array panels begin to hang up or fold incorrectly, as was seen on STS-116, Forrester and Swanson, already preparing to leave the airlock, would be available to make initial attempts to correct the issue. They will carry the same suite of tools wrapped with insulating tape and use the same techniques developed during STS-116. Archambault will operate the station robotic arm during the spacewalk

The ground control team also can try to free guide wires stuck on grommets on the panels before the spacewalk begins by commanding the array's Beta Gimbal Assembly (BGA) to rotate in one direction and then the other.

After spending a little spacewalk time with the solar array retraction, if needed, the spacewalkers will continue releasing launch locks and restraints on the SARJ to allow its activation.

The first task on the truss will be the deployment of the SARJ brace beams. These beams are on the S3 inboard side of the SARJ. They help rigidize the SARJ interface. Forrester and Swanson each will deploy two braces.

Forrester then will complete the installation of the DLAs that was started by Reilly on the first spacewalk. Next he will join Swanson in removing the SARJ launch locks and restraints simultaneously throughout the rest of the spacewalk.

Removal of the launch restraints proved difficult during the STS-115 mission's installation of the P3/P4 truss segment. The STS-117 spacewalkers will be carrying with them an additional tool, called a torque multiplier, to make the task easier.

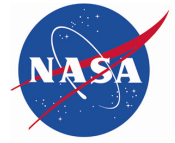

**Patrick Forrester, STS-117 mission specialist, dons a training version of the EMU spacesuit prior to rehearsing a spacewalk at the NBL.**

If time allows, there are additional tasks for Forrester and Swanson. These get-ahead tasks include clearing the Mobile Transporter railway on top of the new truss by removing or relocating various hardware.

### **EVA 3**

If the P6 starboard solar array has not been retracted before the third spacewalk, Reilly and Olivas will work on it. They will be prepared to work on problems seen during the STS-116 mission, such as guide wires on the solar arrays getting stuck in grommets along the way and the panels folding backwards during the retraction.

The spacewalkers can use the same tools as STS-116 to reset the grommets, push on the

panels to fold correctly, fluff or spread the panels equally apart and gently shake the panels from the base.

Get-ahead tasks include clearing the railway on the truss for the Mobile Transporter, installing a water to hydrogen vent on the outside of the Destiny lab for the future activation of the Oxygen Generation System, installing an EWIS antenna and routing local area network (LAN) cables around the Unity Node and Zvezda Service Module.

Additional get-ahead tasks include installing a Video Stanchion Support Assembly, working on S-band Antenna Structural Assembly gimbal locks and retrieving the Global Positioning System antenna No. 4.



**STS-117 mission specialist Steven Swanson adjusts his communications equipment on his EMU before engaging in spacewalk training.**



This page intentionally left blank.

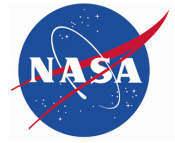

## PAYLOAD OVERVIEW

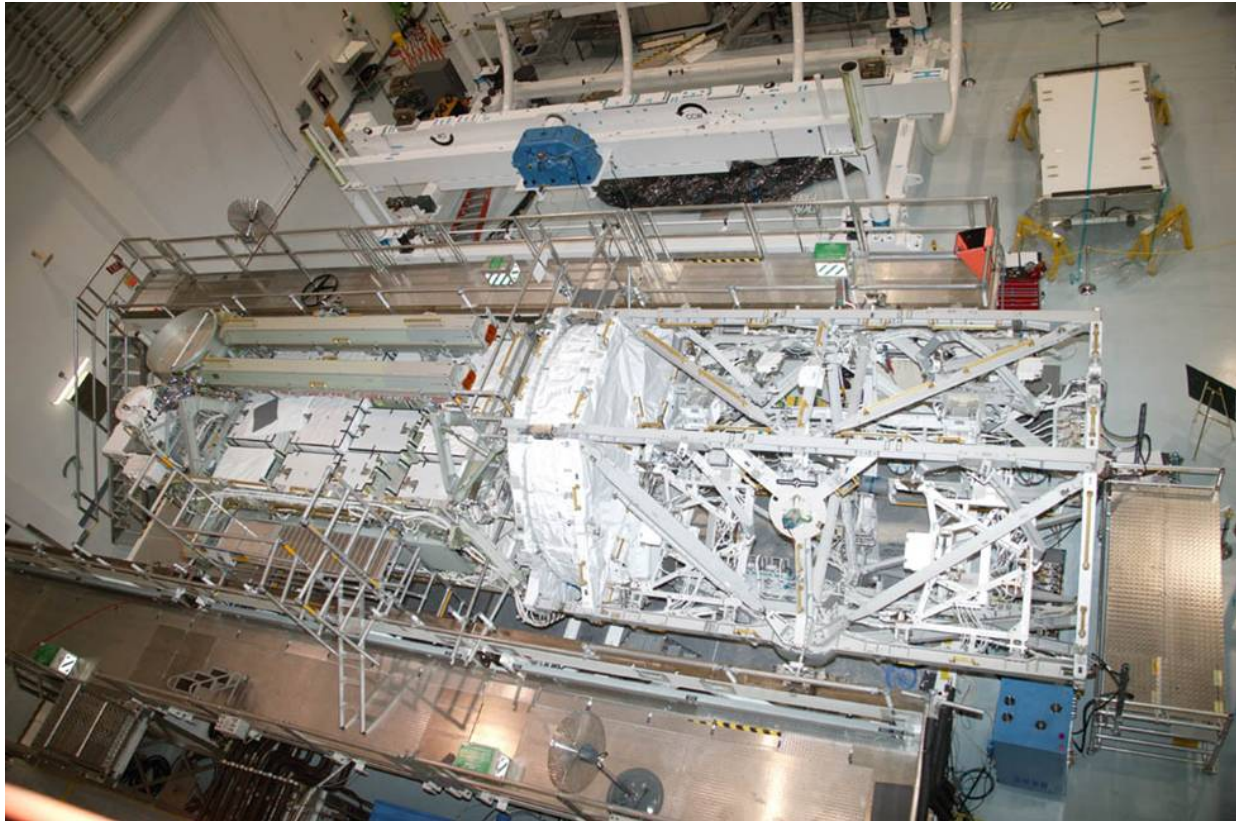

### INTEGRATED TRUSS SEGMENTS S3 AND S4

The Starboard Three (S3) and Starboard Four (S4) integrated truss segments are the primary payload delivered on the STS-117 mission and the heaviest space station payload to date. The principal functions of the S3 and S4 truss segments are to provide electrical power and data interfaces for future mission payloads and convert sunlight to electricity. The segments will include another set of Solar Array Wings (SAWs) and a second Solar Alpha Rotary Joint (SARJ).

Designed by The Boeing Company, the S3/S4 truss segments will be the second starboard ad-

dition to the 11-segment integrated truss structure that will eventually span more than 300 feet to carry power, data and temperature control for the orbital outpost's electronics.

### MIDDECK PAYLOAD

In addition to S3/S4, Space Shuttle Atlantis will carry in its middeck a Hydrogen (H<sup>2</sup>) Vent Valve that will be installed during the mission's third spacewalk. The Hydrogen Vent Valve is part of the Oxygen Generation System (OGS) and will be used to vent Hydrogen overboard. The OGS will help produce oxygen for the crew to replace oxygen lost due to experiment use, airlock depressurization and venting.



<b>S3/S4 Specifications</b>	
<b>Dimensions:</b>	<b>44 ft., 9.6 inches long (13.656 m) by 16 ft., 3.4 inches wide (4.965 m) by 15 ft., 2.3 inches high (4.631 m)</b>
<b>Weight:</b>	<b>35,678 lbs</b>

Other items being carried in the middeck include a contingency water container for transferring water to the station, a tool “modified torque multiplier” for removing S3 launch restraints and audio interface hardware to troubleshoot shuttle-to-station communication difficulties experienced during the last two missions. The payload weight for the middeck during this mission is less than 1,000 pounds.

## **INTEGRATED TRUSS SEGMENTS**

The integrated truss segments started with Starboard zero (S0) as the center assignment and were numbered in ascending order outward to the port and starboard sides. Starboard is the right side and port is the left side of the truss structure. Z is zenith and is up.

From S0, the truss segments are P1, P3, P4, P5 and P6 and S1, S3, S4, S5 and S6. P6 is on orbit and attached to segment Z1 (zenith). The zenith is a spacer added to provide adequate space between the pressurized modules and P6. P6 eventually will be relocated and attached to P5. Plans for S2 and P2 segments were eliminated when the station design was scaled back.

Along with the SAWs and the SARJ, the S3/S4 segments also support utility routing, power distribution and a translation path for the Mobile Remote Service Base System (MBS).

## **PAYLOAD STRUCTURE**

The S3/S4 segments will be removed from the space shuttle payload bay using the shuttle’s robotic arm and handed off to the space station robotic arm, where it will be maneuvered and attached to S1.

Beside two SAWs and a SARJ, the S3/S4 structure has several distinct elements: the Integrated Equipment Assembly (IEA), two Beta Gimbal Assemblies (BGA) and the Photovoltaic Thermal Control Subsystem (PVTCS).

### **Starboard 3 (S3)**

The S3 primary structure is made of a hexagonal-shaped aluminum structure and includes four bulkheads and six longerons, beams that connect the bulkheads. The secondary structure includes brackets, fittings, attach platforms, extravehicular activity equipment and miscellaneous mechanisms.

The major S3 subsystems include the SARJ, Segment-to-Segment Attach System (SSAS) and Payload Attach System (PAS). The S3 truss segment will provide mechanical, power and data interfaces to payloads attached to the four PAS platforms; axial indexing for solar tracking via the SARJ; translation and work site accommodations for the Mobile Transporter; accommodations for ammonia servicing of the outboard PV modules and two Multiplexer/Demultiplexers (MDMs). The MDMs are basically computers that tell other electrical components when to turn on and off and monitor hardware. The S3 also provides a passive attachment point to the S1 segment via the SSAS and pass through of power and data to and from the outboard segments.



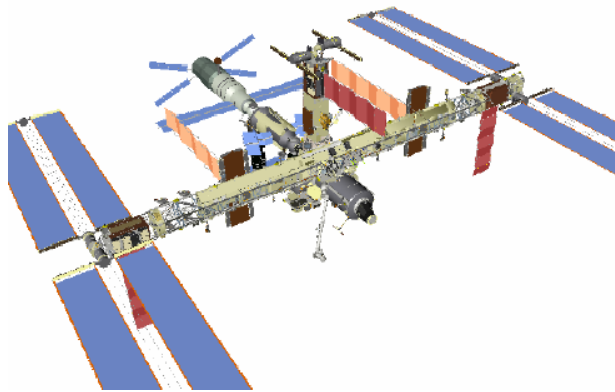

S3/S4 is shown on the left at Stage 13A complete.

The SARJ continuously rotates to keep the SAW on S4 and S6 (S6 is scheduled for launch on shuttle mission STS-119, targeted for no earlier than June 2008) oriented toward the sun as the station orbits the Earth. Each SAW is also oriented by the BGA, which can change the pitch of the wing. Each wing measures 115 feet by 38 feet and extends out to each side of the Integrated Equipment Assembly. There are two wings on S4.

The PAS will allow platforms to be attached to S3 for the storage of additional science payloads or spare Orbital Replacement Units (ORUs). ORUs are space station components that can be removed and replaced for maintenance and stored on the station for future needs. The PAS has a capture latch to grip and secure a payload, a berthing target to align payloads to the mechanism and an Umbilical Mechanism Assembly that has a connector for providing power and data to the payload.

### Starboard 4 (S4)

Major subsystems of the S4 truss are the port inboard Photovoltaic Module (PVM), the Photovoltaic Radiator (PVR), the Alpha Joint Interface Structure (AJIS) and the Modified Rocketdyne Truss Attachment System (MRTAS).

The S4 PVM includes all equipment outboard of the SARJ outboard bulkhead, namely the two Photovoltaic Array Assemblies (PVAAs) and the Integrated Equipment Assembly (IEA). The PVR provides thermal cooling for the IEA. The AJIS provides the structural transition between S3 and S4. Each PVAA consists of a SAW and BGA. S4 also contains the passive side of the MRTAS that will provide the structural attachment for the S5 truss.

## MAJOR ELEMENTS

### Photovoltaic Module (PVMs)

S4 will house the third of four PVMs that will eventually be brought up to the station, converting sunlight to electricity. The primary functions of the power module are to collect, convert, store and distribute electrical power to loads within the segment and to other station segments. Electrical power is the most critical resource for the station because it allows astronauts to live comfortably, safely operate the station and perform complex scientific experiments. Since the only readily available source of energy for spacecraft is sunlight, technologies were developed to efficiently convert solar energy to electrical power.

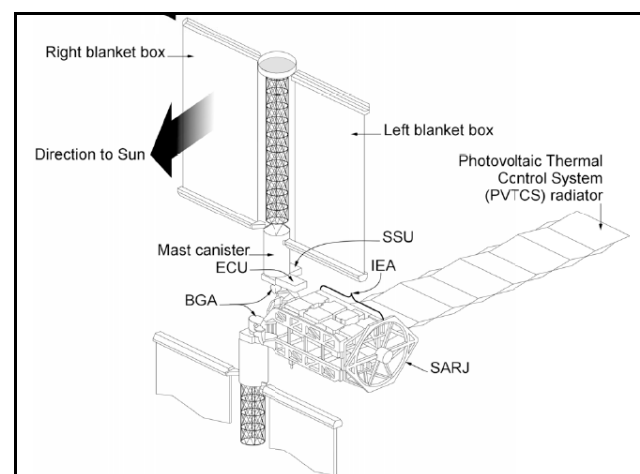



The PVMs use large numbers of solar cells assembled onto solar arrays to produce high power levels. NASA and Lockheed Martin developed a method of mounting the solar arrays on a "blanket" that can be folded like an accordion for delivery to space and then deployed to their full size once in orbit. The cells are made from purified crystal ingots of silicon that directly convert light to electricity for immediate use through a process called photovoltaics.

Gimbals are used to rotate the arrays to face the sun to provide maximum power for the space station. After the conversion process, the PVMs also use the electricity to recharge onboard batteries for continuous sources of electricity while the station is in the Earth's shadow. The complete power system, consisting of U.S. and Russian hardware, will generate 2,000 kWh (kilowatt-hours) of total energy, about as much as 42 2,800-square-foot houses would typically use in a day.

PVM components were assembled by The Boeing Company in Tulsa, Okla., and Lockheed Martin in Sunnyvale, Calif., before final assembly and testing by Boeing at Kennedy Space Center, Fla.

### **Solar Array Wings (SAW)**

There are two SAWs designed, built and tested by Lockheed Martin in Sunnyvale, Calif., on the S4 module, each deployed in the opposite direction from each other. Each SAW is made up of two solar blankets mounted to a common mast. Before deployment, each panel is folded accordion style into a Solar Array Blanket Box (SABB) measuring 20 inches high and 15 feet in length. Each blanket is only about 20 inches thick while in this stored position. The mast consists of interlocking battens that are stowed

for launch inside a Mast Canister Assembly (MCA) designed, built and tested by ATK-Able.

When deployed by the astronauts, the SAW deploys like an erector set as it unfolds. Like a human torso, it has two arms when mounted on S4, and they are rotated outward by astronauts during a spacewalk so they can be fully deployed. Because these blankets were stored for such a long time, NASA, Boeing and Lockheed Martin conducted extensive testing to ensure they would unfold properly once on orbit so the blankets would not stick together. This testing was completed in July 2003 and proved to be successful when the P4 solar array was successfully deployed on STS-115 in September.

When fully deployed, the SAW extends 115 feet and spans 38 feet across and extends to each side of the Integrated Equipment Assembly. Since the second SAW is deployed in the opposite direction, the total wing span is more than 240 feet.

Each SAW weighs more than 2,400 pounds and uses 32,800 solar array cells per wing, each measuring 8-cm square with 4,100 diodes. The individual cells were made by Boeing's Spectrolab and ASEC. There are 400 solar array cells to a string and there are 82 strings per wing.

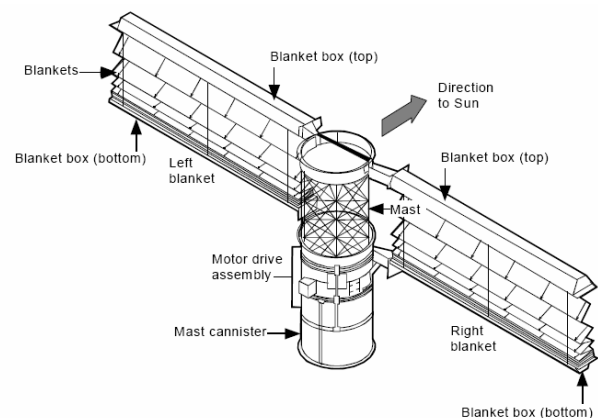



Each SAW is capable of generating nearly 32.8 kilowatts (kW) of direct current power. There are two SAWs on the S4 module, yielding a total power generation capability approaching 66 kW, enough power to meet the electrical needs of about 30 2,800-square-foot houses, consuming about 2kW of power each.

### **Solar Alpha Rotary Joint (SARJ)**

S3 consists of the SARJ, which continuously rotates to keep the solar array wings on S4 and S6 oriented toward the sun as the station orbits the Earth. Located between S3 and S4, the SARJ is a 10.5-foot diameter rotary joint that tracks the sun in the alpha axis that turns the entire S4 module. The SARJ weighs approximately 2,500 pounds. The SARJ can spin 360 degrees using bearing assemblies and a servo control system to turn. All of the power will flow through the Utility Transfer Assembly (UTA) in the SARJ. Roll ring assemblies allow transmission of data and power across the rotating interface so it never has to unwind. Under contract to Boeing, the SARJ was designed, built and tested by Lockheed Martin in Sunnyvale, Calif.

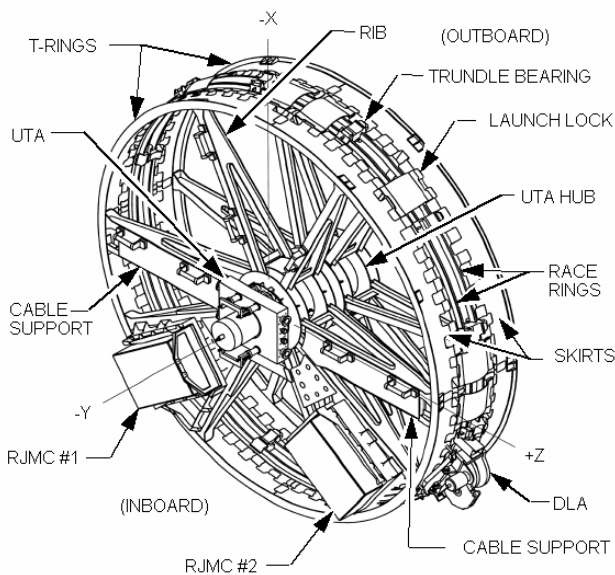

### **Beta Gimbal Assembly (BGA)**

The solar array wings also are oriented by the BGA, which can change the pitch of the wings by spinning the solar array. The BGA measures 3 cubic feet and provides a structural link between the Integrated Equipment Assembly (IEA.) The BGA's most visual functions are to deploy and retract the SAW and rotate it about its longitudinal axis. The BGA consists of three major components mounted on the BGA Platform: the Bearing, Motor and Roll Ring Module (BMRRM), the Electronic Control Unit (ECU) and the Beta Gimbal Transition Structure. The BGA was designed by Boeing Rocketdyne in Canoga Park, Calif., which has since been acquired by Pratt and Whitney. The Sequential Shunt Unit (SSU) that serves to manage and distribute the power generated from the arrays also is mounted on each BGA platform. The SSU was designed by Space Systems/Loral.

Both the SARJ and BGA are pointing mechanisms and mechanical devices used to point the arrays toward the sun. They can follow an angle target and rotate to that target in the direction toward the sun. On-orbit controllers continuously update those targets so it keeps moving as the station orbits the Earth every 90 minutes, maintaining contact with the sun at the same orbital rate. The SARJ mechanism will move much more than the BGA, which moves about four or five degrees per day. The SARJ will rotate 360 degrees every orbit, or about 4 degrees per minute.

### **S4 Integrated Equipment Assembly (IEA)**

The IEA has many components: 12 battery sub-assembly Orbital Replacement Units (ORUs), six Battery Charge/Discharge Units (BCDU)



ORUs, two Direct Current Switching Units (DCSUs), two Direct Current to Direct Current Converter Units (DDCUs), and two Photovoltaic Controller Units (PVCUs). The IEA integrates the Thermal Control Subsystem that consists of one Photovoltaic Radiator (PVR) ORU and two Pump Flow Control Subassembly (PFCS) ORUs used to transfer and dissipate heat generated by the IEA ORU boxes. In addition, the IEA provides accommodation for ammonia servicing of the outboard PV modules, as well as pass through of power and data to and from the outboard truss elements. The structural transition between the S3 and S4 segments is provided by the Alpha Joint Interface Structure (AJIS).

The IEA measures 16 cubic feet, weighs nearly 17,000 pounds and is designed to condition and store the electrical power collected by the photovoltaic arrays for use on board the station.

The IEA integrates the energy storage subsystem, the electrical distribution equipment, the thermal control system and structural framework. The IEA consists of three major elements:

1. The power system electronics consisting of the Direct Current Switching Unit (DCSU) used for primary power distribution; the Direct Current to Direct Current Converter Unit (DDCU) used to produce regulated secondary power; the Battery Charge/Discharge Unit (BCDU) used to control the charging and discharging of the storage batteries; and the batteries used to store power.
2. The Photovoltaic Thermal Control System (PVTCS) consisting of: the coldplate subas-

sembly used to transfer heat from an electronic box to the coolant; the Pump Flow Control Subassembly (PFCS) used to pump and control the flow of ammonia coolant; and the Photovoltaic Radiator (PVR) used to dissipate the heat into deep space. Ammonia, unlike other chemical coolants, has significantly greater heat transfer properties.

3. The computers used to control the S4 module ORUs consisting of two Photovoltaic Controller Unit (PVCU) Multiplexer/Demultiplexers (MDMs).

The IEA power system is divided into two independent and nearly identical channels. Each channel is capable of control (fine regulation), storage and distribution of power to the station. The two PVAAAs are attached to the outboard end of the IEA and the AJIS to the inboard end.

### **Direct Current Switching Unit (DCSU)**

Power received from each PVAA is fed directly into the appropriate DCSU, a high-power, multi-path remotely controlled unit used for primary and secondary power distribution, protection and fault isolation within the IEA. The DCSU also distributes primary power to the station. During periods of isolation (sunlight), the DCSU routes primary power directly to the station from its PVAA and also routes power to the power storage system for battery charging. During periods of eclipse, the DCSU routes power from the power storage system to the station. The DCSU measures 28 inches by 40 inches by 12 inches and weighs 238 pounds.



## **Direct Current to Direct Current Converter Unit (DDCU)**

Primary power from the DCSU also is distributed to the DDCU, a power processing system that conditions the coarsely regulated power from the PVAA to 123 +/- 2 VDC. It has a maximum power output of 6.25 kW. This power is used for all S4 operations employing secondary power. By transmitting power at higher voltages and stepping it down to lower voltages where the power is to be used, much like municipal power systems, the station can use smaller wires to transmit this electrical power and thus reduce launch loads. The converters also isolate the secondary system from the primary system and maintain uniform power quality throughout the station. The DDCU measures 27.25 inches by 23 inches by 12 inches and weighs 129 pounds.

Primary power from the DCSU also is distributed to the three power storage systems within each channel of the IEA. The power storage system consists of a Battery Charge/Discharge Unit (BCDU) and two battery subassembly ORUs. The BCDU serves a dual function of charging the batteries during solar collection periods and providing conditioned battery power to the primary power busses (via the DCSU) during eclipse periods. The BCDU has a battery charging capability of 8.4 kW and a discharge capability of 6.6 kW. The BCDU also includes provisions for battery status monitoring and protection from power circuit faults. Commanding of the BCDU is from the PVCU. The BCDU measures 28 inches by 40 inches by 12 inches and weighs 235 pounds.

Each battery subassembly ORU consists of 38 lightweight nickel hydrogen cells and associated electrical and mechanical equipment. Two

battery subassembly ORUs connected in series are capable of storing 8 kW of electrical power. This power is fed to the station via the BCDU and DCSU, respectively. The batteries have a design life of 6.5 years and can exceed 38,000 charge/discharge cycles at 35 percent depth of discharge. Each battery measures 41 inches by 37 inches by 19 inches and weighs 372 pounds. Because of delays in launching the S3/S4 elements, the lower deck batteries were replaced on Sept. 16, 2006.

## **Photovoltaic Thermal Control System (PVTCS)**

To maintain the IEA electronics at safe operating temperatures in the harsh space environments, they are conditioned by the PVTCS. The PVTCS consist of ammonia coolant, 11 coldplates, two Pump Flow Control Subassemblies (PFCS) and one Photovoltaic Radiator (PVR).

The coldplate subassemblies are an integral part of the IEA structural framework. Heat is transferred from the IEA orbital replacement unit (ORU) electronic boxes to the coldplates via fine interweaving fins located on both the coldplate and the electronic boxes. The fins add lateral structural stiffness to the coldplates in addition to increasing the available heat transfer area.

## **Pump Flow Control Subassemblies (PFCS)**

The PFCS is the heart of the thermal system, consisting of all the pumping capacity, valves and controls required to pump the heat transfer fluid to the heat exchanges and radiator, and regulate the temperature of the thermal control system ammonia coolant. The PVTCS is designed to dissipate 6,000 Watts of heat per orbit on average and is commanded by the IEA



computer. Each PFCS consumes 275 Watts during normal operations and measures approximately 40 by 29 by 19 inches, weighing 235 pounds.

### Photovoltaic Radiator (PVR)

The PVR—the radiator—is deployable on orbit and comprised of two separate flow paths through seven panels. Each flow path is independent and is connected to one of the two PFCSs on the IEA. In total, the PVR can reject up to 14 kW of heat into deep space. The PVR weighs 1,633 pounds and when deployed measures 44 by 12 by 7 feet.

### S3/S4 Facts in Brief

**Manufacturer:** The Boeing Company

**Dimensions:** 44 feet 9.6 inches long by 16 feet 3.4 inches wide by 15 feet 2.3 inches high

**Weight:** 35,678 lbs

**Cost:** \$367,337,000

**Structure:** Primarily aluminum

**Major components:** The S3 primary structure is made of a hexagonal shaped aluminum structure and includes four bulkheads and six

longerons. The secondary structure includes brackets, fittings, attach platforms, EVA equipment and miscellaneous mechanisms. The S4 Photovoltaic module includes all equipment outboard of the Solar Alpha Rotary Joint (SARJ) outboard bulkhead, namely the two Photovoltaic Array assemblies and the Integrated Equipment Assembly (IEA).

**Purpose:** The S3 and S4 carry power, data and environmental services along the integrated truss structure. Also, they provide active thermal protection to electrical components throughout the station and allow the connection of platforms to store spare parts.

**Construction:** S3 was designed by the Boeing design team at Huntington Beach, Calif. Boeing (now Pratt and Whitney) Rocketdyne Power and Propulsion in Canoga Park, Calif. designed S4. Assembly of S3 and S4 was in Tulsa, Okla. S3 was delivered to the Space Station Processing Facility at Kennedy Space Center on Dec. 7, 2000, and S4 was delivered on Jan. 15, 2001. S3 and S4 were handed off to NASA in September 2002.

**Major Subcontractors:** Lockheed Martin, Honeywell, Hamilton Sundstrand, Pratt and Whitney Rocketdyne

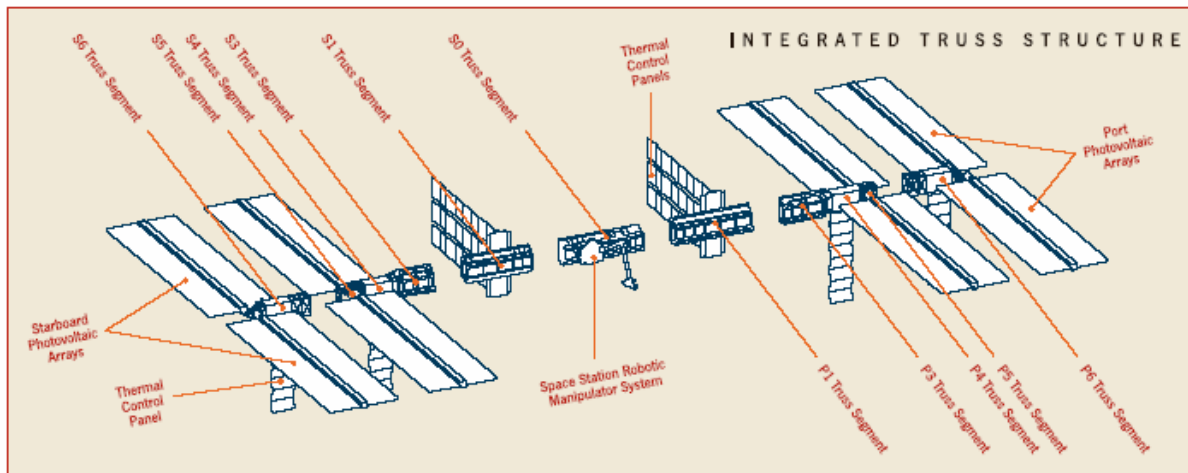



**Unberthing and Installation:**

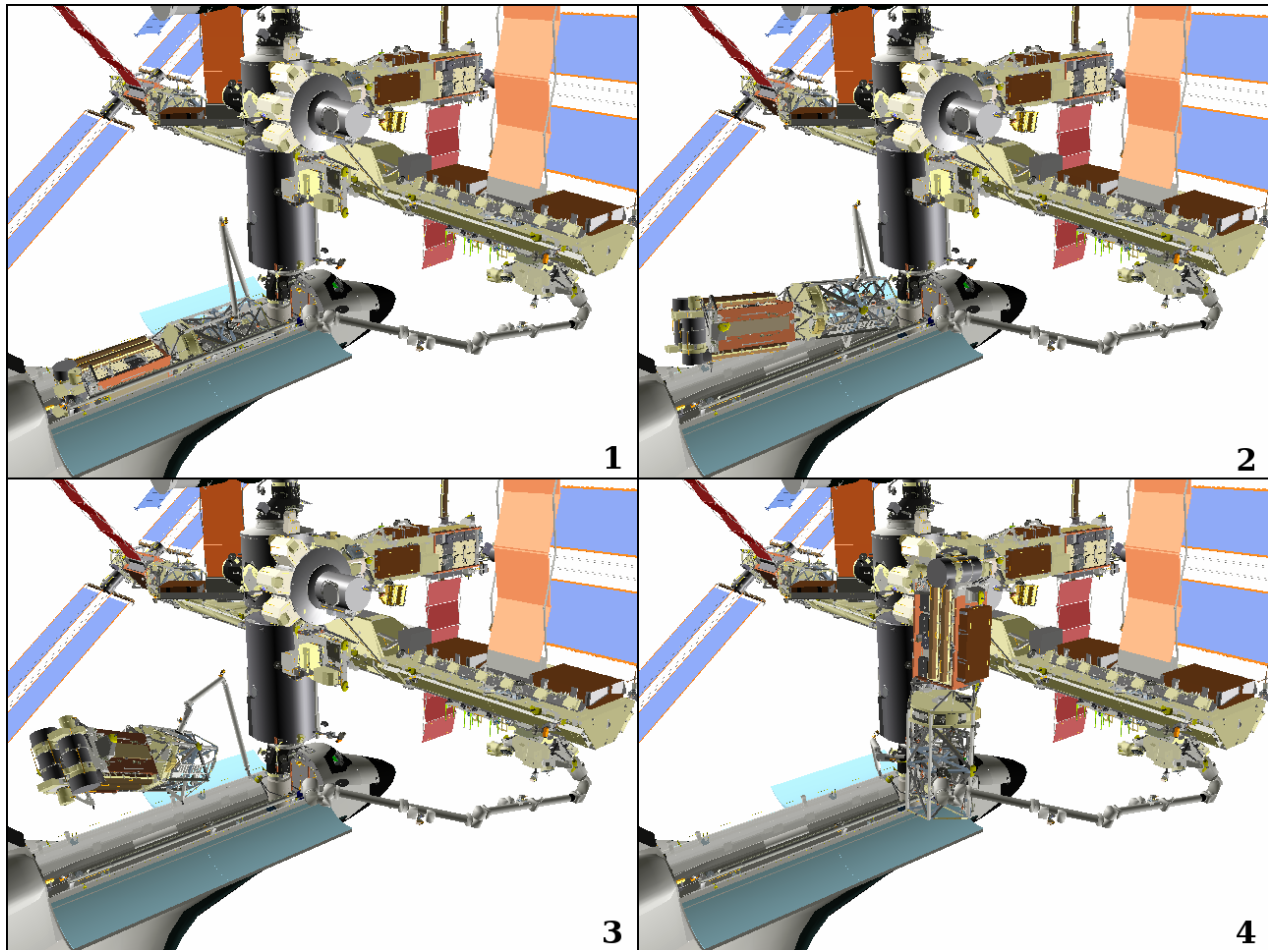

S3/S4 SRMS unberth during STS-117 and SSRMS handoff operations are shown above.

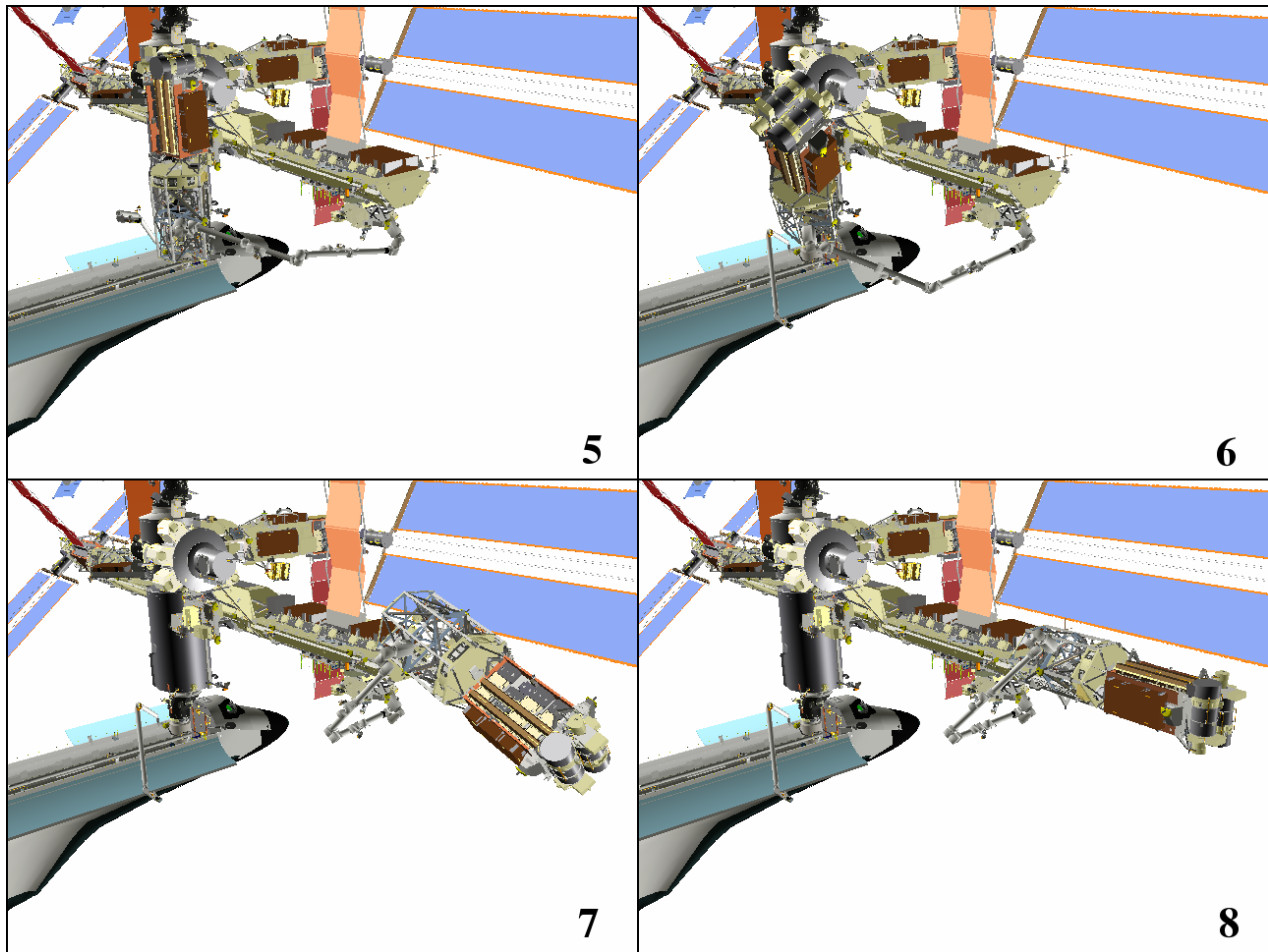

S3/4 SSRMS maneuver and installation is shown above.





## EXPERIMENTS

### DETAILED TEST OBJECTIVES

Detailed Test Objectives (DTOs) are aimed at testing, evaluating or documenting space shuttle systems or hardware, or proposed improvements to the space shuttle or space station hardware, systems and operations.

Such experiments assigned to STS-117 are listed below.

#### **DTO 805 Crosswind Landing Performance (If Opportunity)**

The purpose of this DTO is to demonstrate the capability to perform a manually controlled landing in the presence of a crosswind. The testing is done in two steps.

1. Pre-launch: Ensure planning will allow selection of a runway with Microwave Scanning Beam Landing System support, which is a set of dual transmitters located beside the runway providing precision navigation vertically, horizontally and longitudinally with respect to the runway. This precision navigation subsystem helps provide a higher probability of a more precise landing with a crosswind of 10 to 15 knots as late in the flight as possible.
2. Entry: This test requires that the crew perform a manually controlled landing in the presence of a 90-degree crosswind component of 10 to 15 knots steady state. During a crosswind landing, the drag chute will be deployed after nose gear touchdown when the vehicle is stable and tracking the runway centerline.

### SHORT-DURATION BIOASTRONAUTICS INVESTIGATION (SDBI)

Short-Duration Bioastronautics Investigations (SDBIs) are shuttle-based, life science payloads, experiments and technology demonstrations.

#### **SDBI 1503S Test of Midodrine as a Countermeasure against Postflight Orthostatic Hypotension**

Presently, there are no medications or treatment to eliminate orthostatic hypotension, a condition that often affects astronauts following spaceflight. Orthostatic hypotension is a sudden drop in blood pressure that occurs when a person assumes a standing position. Symptoms, which generally occur after sudden standing, include dizziness, lightheadedness, blurred vision and a temporary loss of consciousness. Space alters cardiovascular function, and orthostatic hypotension is one of the alterations that negatively impacts crew safety. Susceptibility to orthostatic hypotension is individual, with some astronauts experiencing severe symptoms, while others are less affected. This countermeasure evaluation proposal, sponsored by the Countermeasures Evaluation and Validation Project, is in its second phase of the evaluation of midodrine. It is designed to give the greatest opportunity of measuring the maximum efficacy of the drug. This experiment will measure the effectiveness of midodrine in reducing the incidence and, or, the severity of orthostatic hypotension in returning astronauts. Its effectiveness will be evaluated with an expanded tilt test.



## **SHORT-DURATION RESEARCH AND STATION EXPERIMENTS**

### **Short-duration research to be performed during STS-117**

The Space Shuttle and International Space Station Programs have an integrated research plan that optimizes use of shuttle crew members and long-duration station crew members to address research questions in a variety of disciplines.

**Maui Analysis of Upper Atmospheric Injections (MAUI)** will observe the exhaust plume of the space shuttle and will lead to assessment of spacecraft plume interactions with the upper atmosphere.

**Test of Midodrine as a Countermeasure Against Post-Flight Orthostatic Hypotension (Midodrine)** is a test of the ability of the drug midodrine to reduce the incidence or severity of orthostatic hypotension. If successful, it will be used as a countermeasure to the dizziness caused by the blood-pressure decrease that many astronauts experience upon returning to the Earth's gravity.

**Perceptual Motor Deficits in Space (PMDIS)** will investigate why astronauts experience difficulty with hand-eye coordination while on orbit. These measurements will be used to distinguish between three possible explanations: the brain not adapting to the near weightlessness of space; the difficulty of performing fine movements when floating in space; and stress due to factors such as space sickness and sleep deprivation.

**Ram Burn Observations (RAMBO)** is an experiment in which the Department of Defense uses a satellite to observe space shuttle orbital maneuvering system engine burns. Its purpose

is to improve models that predict the direction the plume, or exhaust, will move as the shuttle maneuvers on orbit. Understanding the plume's flow could be significant to the safe arrival and departure of spacecraft on current and future exploration missions.

### **ISS research samples returned on STS-117**

**Commercial Generic Bioprocessing Apparatus Science Insert - 01 (CSI-01)** is comprised of two educational experiments that will be utilized by middle school students in the United States and Malaysia. One experiment is examining seed germination in microgravity including gravitropism (plant growth towards gravity) and phototropism (plant growth towards light). The second experiment is examining how microgravity affects a small nematode worm, *Caenorhabditis elegans*. Thousands of students began participating in the experiments in February 2007.

The **Renal Stone** experiment tests the effectiveness of potassium citrate in preventing renal stone formation during long-duration spaceflight. Kidney stone formation, a significant risk during long missions, could impair astronaut functionality.

**Stability of Pharmacotherapeutic and Nutritional Compounds (Stability)** will study the effects of radiation in space on complex organic molecules, such as vitamins and other compounds in food and medicine. This will help in developing more stable and reliable pharmaceutical and nutritional countermeasures suitable for future long-duration missions to the moon and Mars. A package of food and drugs kept on orbit for six months will be returned on this shuttle flight.



**A Comprehensive Characterization of Microorganisms and Allergens in Spacecraft (SWAB)** will use advanced molecular techniques to comprehensively evaluate microbes on board the space station, including pathogens—organisms that may cause disease. It also will track changes in the microbial community as spacecraft visit the station and new station modules are added. This study will allow an assessment of the risk of microbes to the crew and the spacecraft. Additional Space Station Research From Now Until the End of Expedition 14

### **ISS Research from now through STS-118**

**Anomalous Long Term Effects in Astronauts' Central Nervous System (ALTEA)** integrates several diagnostic technologies to measure the exposure of crew members to cosmic radiation. It will further our understanding of radiation's impact on the human central nervous and visual systems, especially the phenomenon of crew members seeing phosphenes, or flashes of light, while in orbit.

**Crew Earth Observations (CEO)** takes advantage of the crew in space to observe and photograph natural and human-made changes on Earth. The photographs record the Earth's surface changes over time, along with more fleeting events such as storms, floods, fires and volcanic eruptions.

**Crew Earth Observations - International Polar Year (CEO-IPY)** is an international collaboration of scientists for the observation and exploration of Earth's polar regions from 2007 to 2009. Station crew members will photograph polar phenomena including auroras and mesospheric clouds in response to a daily message from the scientists on the ground.

**Behavioral Issues Associated with Isolation and Confinement: Review and Analysis of Astronaut Journals (Journals)**, using journals kept by the crew and surveys, studies the effect of isolation to obtain quantitative data on the importance of different behavioral issues in long-duration crews. Results will help NASA design equipment and procedures to allow astronauts to best cope with isolation and long-duration spaceflight.

**Microgravity Acceleration Measurement System (MAMS) and Space Acceleration Measurement System (SAMS-II)** measure vibration and quasi-steady accelerations that result from vehicle control burns, docking and undocking activities. The two different equipment packages measure vibrations at different frequencies.

**Materials on the International Space Station Experiment 3 and 4 (MISSE – 3 and 4)** are the third and fourth in a series of five suitcase-sized test beds attached to the outside of the space station. The beds were deployed during a spacewalk on STS-121 in July 2006. They will expose hundreds of potential space construction materials and different types of solar cells to the harsh environment of space. After being mounted to the space station about a year, the equipment will be returned to Earth for study. Investigators will use the resulting data to design stronger, more durable spacecraft.

**Nutritional Status Assessment (Nutrition)** is the most comprehensive in-flight study done by NASA of human physiologic changes during long-duration spaceflight; this includes measures of bone metabolism, oxidative damage, nutritional assessments, and hormonal changes. This study will impact both the definition of nutritional requirements and development of food systems for future space exploration mis-

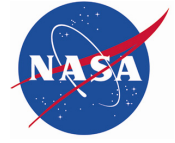

sions to the moon and Mars. This experiment will also help to understand the impact of countermeasures (exercise and pharmaceuticals) on nutritional status and nutrient requirements for astronauts.

**Synchronized Position Hold, Engage, Reorient, Experimental Satellites (SPHERES)** are bowling-ball sized spherical satellites. They will be used inside the space station to test a set of well-defined instructions for spacecraft performing autonomous rendezvous and docking maneuvers. Three free-flying spheres will fly within the cabin of the station, performing flight formations. Each satellite is self-contained with power, propulsion, computers and naviga-

tion equipment. The results are important for satellite servicing, vehicle assembly and formation flying spacecraft configurations.

**Sleep-Wake Actigraphy and Light Exposure During Spaceflight-Long (Sleep-Long)** will examine the effects of spaceflight and ambient light exposure on the sleep-wake cycles of the crew members during long-duration stays on the space station.

**Test of Reaction and Adaptation Capabilities (TRAC)** will test the theory of brain adaptation during spaceflight by testing hand-eye coordination before, during and after a long-duration stay on the station.



## EXTERNAL TANK ET-124 REPAIRS



In late February, Atlantis' external tank received hail damage during a severe thunderstorm that passed through the Kennedy Space Center Launch Complex 39 area. The hail caused visible divots in the giant tank's foam insulation, as well as minor surface damage to about 26 heat shield tiles on the shuttle's left wing.



Repairs to space shuttle Atlantis' external fuel tank ET-124 were completed May 11 in NASA's Kennedy Space Center's Vehicle Assembly Building after a Feb. 26 hail storm passed over the launch pad as the vehicle was being prepared for launch. The storm left the tank with more than 4,000 damage sites requiring repair, which delayed launch from March 15 to June.

The storm produced golf-ball-size hail, which caused significant damage to the external fuel tank foam, mostly on the upper part of the tank. Immediately after the storm, NASA managers decided to roll the shuttle from the launch pad back to the Vehicle Assembly Building to assess the full extent of the damage and to develop detailed repair plans.



Technicians work on repair techniques to the hail-damaged external tank. They are inside a tented area that protects the tank. Scaffolding around the tank can be seen below.



**In Highway 1 inside the Vehicle Assembly Building, technicians carefully sand away the red dye that has been applied to the external tank to help expose cracks or compression dents.**

Teams from NASA's Marshall Space Flight Center in Huntsville, Ala., Kennedy Space Center in Fla., and the Michoud Assembly Facility in New Orleans performed an initial damage assessment. Since a hands-on inspection was required to determine the depth of damage, workers constructed an intricate network of scaffolding and platforms around the shuttle to allow access to all of the hail-damaged areas that were then "mapped" to indicate damage location, size and depth. This initial assessment showed damage in all quadrants of the tank, from the liquid oxygen tank ogive, the pointed nose section, to the aft interface hardware where the orbiter is attached. A ther-

mal/aerothermal assessment was performed for each damage site to determine the required extent of repair.

About 1,400-1,500 of the damage sites were near the top of the tank in a location known as the "pencil sharpener" area. This high density of damage led to a decision to remove a half-inch thick layer of foam in the entire area to eliminate all damage. This process was used to avoid numerous individual repairs. The removed material was replaced with a single, large manually applied spray using a type of material referred to as "BX" foam. This same "remove damage and spray a replacement layer" technique was used to repair a large area of



damaged foam covering almost 500 damage sites on the side of the liquid oxygen tank. While BX material has been flown in numerous applications on Return-to-Flight hardware, these spray repairs required a demonstration to ensure that the application process was repeatable and the performance meets or exceeds thermal protection and debris minimization requirements.

Engineers and technicians devised a high fidelity mock-up of the top of the tank at the Michoud Assembly Facility and duplicated the exact conditions in which they would be working on the spray and final foam machining

process in Florida. This included replicating the precise access and narrow spaces around the platform in the Vehicle Assembly Building. The team also practiced the manual spray and tested and dissected the completed demonstration repair.

After the manual spray at the top of the actual tank was completed, technicians used a new portable tool they devised at Michoud to trim and machine the foam to the precise dimensions required in this “pencil sharpener” area. This unique pneumatic tool fits down over the tank's nose cone spike and sands the foam with a sandpaper covered roller.



**In NASA Kennedy Space Center's Vehicle Assembly Building, one technician adjusts the sander while another observes as they work on repairing the hail damage to Atlantis' nose cone.**





Approximately 2,500 other sites on the hail-damaged tank were repaired using a mixed repair approach. More than a thousand of these were repaired by removing the damaged foam with a mechanical grinding tool and reapplying specialized pourable foam, known as "PDL." This two-step process has been developed and perfected over several years and is routinely used at the Michoud factory to repair incidental damage to the foam material that can occur during tank construction. Almost 900 of the damage sites were shallow enough to be repaired using a technique called "sand and blend" in which the crushed foam was sanded away by hand using coarse sandpaper and the resulting slight depression was smoothly "blended" into the surrounding foam. This repair process was only feasible where analysis and testing showed adequate foam thickness would remain to protect against ice formation before launch and heating during ascent. Maintaining proper propellant quality (temperature and density) as well as proper "break-up" performance during tank re-entry into the atmosphere following use were also considerations as was compliance with surface waviness requirements. The remaining 400 damage sites did not require repair, although they were cataloged since each required the same rigorous engineering analysis as the repaired damage. This barely visible minor damage will be flown

"as is," because the conditions and locations are such that they can still meet all the design requirements.

The repaired areas of ET-124 appear nearly white compared to the orange color of the rest of the tank. This is not a problem, as all criteria have been met to return the tank to a flight worthy condition. Only the "pencil sharpener" area received a special coat of protective dark paint to protect the foam where it contacts the gaseous oxygen vent hood at the launch pad.

The February storm at Kennedy caused the worst damage ever seen to a shuttle from a hail storm. NASA's history of shuttle rollbacks due to hail damage includes STS-38 (Atlantis), which experienced hail damage during rollback Aug. 9, 1990, to troubleshoot a hydrogen leak. Damage occurred while the shuttle was outside the Vehicle Assembly Building and the repairs were made in the VAB. STS-96 (Discovery) experienced hail damage at Pad B on May 8, 1999. Rollback to the VAB was required to fix 650 divots in external tank foam insulation. All of these previous repairs performed as expected.

The ET-124 repair team consisted of engineers and managers from Marshall, Kennedy, Johnson, NASA Headquarters, United Space Alliance, Lockheed Martin contractor teams and support personnel from around the country.



Space Shuttle Atlantis, mounted on a mobile launch platform atop a crawler transporter, passes through the gate to Launch Pad 39A. Atlantis rolled back to the pad on May 15, 2007, following repairs caused by the late February hail damage.



## **SPACE SHUTTLE MAIN ENGINE ADVANCED HEALTH MANAGEMENT SYSTEM**

During the STS-117 mission, the Advanced Health Management System (AHMS)—an engine improvement system that shuts down an engine if anomalies are detected—will be actively operating on one engine for the first time. The AHMS collects and processes turbopump accelerometer data, a measure of turbopump vibration, and continuously monitors turbopump health. If vibration anomalies are detected, the system shuts down the engine. The AHMS will be in monitor-only mode for Atlantis' two other engines, meaning that although data is being collected, the system cannot shut down the engines.

The AHMS was in monitor-only mode on one engine during the STS-116 mission in December 2006. Data from that mission indicated the AHMS operated as intended. The system will be fully operational and in active mode on all engines during shuttle Endeavour's next mission, STS-118.

When a shuttle lifts off the launch pad, it does so with the help of three reusable, high performance rocket engines. Each main engine is 14 feet long and 7.5 feet in diameter at the nozzle exit. One engine weighs approximately 7,750 pounds and generates more than 12 million horsepower, equivalent to more than four times the output of the Hoover Dam. The engines operate for about 8.5 minutes during lift-off and ascent—long enough to burn more than 500,000 gallons of super-cold liquid hydrogen and liquid oxygen propellants stored in the external fuel tank, which is attached to the shuttle's underside. Liquid oxygen is stored at -298 degrees Fahrenheit, and liquid hydrogen is

stored at -423 degrees Fahrenheit. The engines shut down just before the shuttle, traveling at about 17,000 mph, reaches orbit.

This engine upgrade significantly improves space shuttle flight safety and reliability. The upgrade, developed by NASA's Marshall Space Flight Center in Huntsville, Ala., is a modification of the existing main engine controller, which is the on-engine computer that monitors and controls all main engine operations.



**Three Space Shuttle Main Engines protrude from the aft section of the space shuttle, consuming liquid hydrogen and liquid oxygen to help power the shuttle into orbit.**

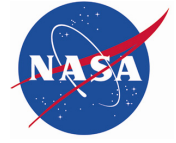

The modifications include the addition of advanced digital signal processors, radiation-hardened memory and new software. These changes to the main engine controller provide the capability for completely new monitoring and insight into the health of the two most complex components of the space shuttle's main engine—the high-pressure fuel turbopump and the high-pressure oxidizer turbopump.

The fuel and oxidizer turbopumps rotate at approximately 34,000 and 23,000 revolutions per minute, respectively. To operate at such extreme speeds, the high-pressure turbopumps use highly specialized bearings and precisely

balanced components. The AHMS upgrade utilizes data from three existing sensors (accelerometers) mounted on each of the high-pressure turbopumps to measure how much each pump is vibrating. The output data from the accelerometers is routed to the new AHMS digital signal processors installed in the main engine controller. These processors analyze the sensor readings 20 times per second, looking for vibration anomalies that are indicative of impending failure of rotating turbopump components such as blades, impellers, inducers and bearings. If the magnitude of any vibration anomaly exceeds safe limits, the upgraded main engine controller immediately shuts down the unhealthy engine.



## SHUTTLE REFERENCE DATA

### SHUTTLE ABORT MODES

#### RSLS Aborts

These occur when the on-board shuttle computers detect a problem and command a halt in the launch sequence after taking over from the ground launch sequencer and before solid rocket booster ignition.

#### Ascent Aborts

Selection of an ascent abort mode may become necessary if there is a failure that affects vehicle performance, such as the failure of a space shuttle main engine or an orbital maneuvering system engine. Other failures requiring early termination of a flight, such as a cabin leak, might also require the selection of an abort mode. There are two basic types of ascent abort modes for space shuttle missions: intact aborts and contingency aborts. Intact aborts are designed to provide a safe return of the orbiter to a planned landing site. Contingency aborts are designed to permit flight crew survival following more severe failures when an intact abort is not possible. A contingency abort would generally result in a ditch operation.

#### Intact Aborts

There are four types of intact aborts: abort to orbit (ATO), abort once around (AOA), trans-oceanic abort landing (TAL) and return to launch site (RTL).

#### Return to Launch Site

The RTL abort mode is designed to allow the return of the orbiter, crew and payload to the

launch site, Kennedy Space Center, approximately 25 minutes after liftoff.

The RTL profile is designed to accommodate the loss of thrust from one space shuttle main engine between liftoff and approximately four minutes 20 seconds, at which time not enough main propulsion system propellant remains to return to the launch site. An RTL can be considered to consist of three stages—a powered stage, during which the space shuttle main engines are still thrusting; an external tank separation phase; and the glide phase, during which the orbiter glides to a landing at the Kennedy Space Center. The powered RTL phase begins with the crew selection of the RTL abort, after solid rocket booster separation. The crew selects the abort mode by positioning the abort rotary switch to RTL and depressing the abort push button. The time at which the RTL is selected depends on the reason for the abort. For example, a three-engine RTL is selected at the last moment, about 3 minutes, 34 seconds into the mission; whereas an RTL chosen due to an engine out at liftoff is selected at the earliest time, about 2 minutes, 20 seconds into the mission (after solid rocket booster separation).

After RTL is selected, the vehicle continues downrange to dissipate excess main propulsion system propellant. The goal is to leave only enough main propulsion system propellant to be able to turn the vehicle around, fly back toward the Kennedy Space Center and achieve the proper main engine cutoff conditions so the vehicle can glide to the Kennedy Space Center after external tank separation. During the downrange phase, a pitch-around maneuver is initiated (the time depends in part on the time



of a space shuttle main engine failure) to orient the orbiter/external tank configuration to a heads-up attitude, pointing toward the launch site. At this time, the vehicle is still moving away from the launch site, but the space shuttle main engines are now thrusting to null the downrange velocity. In addition, excess orbital maneuvering system and reaction control system propellants are dumped by continuous orbital maneuvering system and reaction control system engine thrustings to improve the orbiter weight and center of gravity for the glide phase and landing.

The vehicle will reach the desired main engine cutoff point with less than 2 percent excess propellant remaining in the external tank. At main engine cutoff minus 20 seconds, a pitch down maneuver (called powered pitch-down) takes the mated vehicle to the required external tank separation attitude and pitch rate. After main engine cutoff has been commanded, the external tank separation sequence begins, including a reaction control system maneuver that ensures that the orbiter does not recontact the external tank and that the orbiter has achieved the necessary pitch attitude to begin the glide phase of the RTLS.

After the reaction control system maneuver has been completed, the glide phase of the RTLS begins. From then on, the RTLS is handled similarly to a normal entry.

### **Transoceanic Abort Landing**

The TAL abort mode was developed to improve the options available when a space shuttle main engine fails after the last RTLS opportunity but before the first time that an AOA can be accomplished with only two space shuttle main engines or when a major orbiter system failure, for example, a large cabin pressure leak

or cooling system failure, occurs after the last RTLS opportunity, making it imperative to land as quickly as possible.

In a TAL abort, the vehicle continues on a ballistic trajectory across the Atlantic Ocean to land at a predetermined runway. Landing occurs about 45 minutes after launch. The landing site is selected near the normal ascent ground track of the orbiter to make the most efficient use of space shuttle main engine propellant. The landing site also must have the necessary runway length, weather conditions and U.S. State Department approval. The three landing sites that have been identified for a launch are Zaragoza, Spain; Moron, Spain; and Istres, France.

To select the TAL abort mode, the crew must place the abort rotary switch in the TAL/AOA position and depress the abort push button before main engine cutoff (Depressing it after main engine cutoff selects the AOA abort mode). The TAL abort mode begins sending commands to steer the vehicle toward the plane of the landing site. It also rolls the vehicle heads up before main engine cutoff and sends commands to begin an orbital maneuvering system propellant dump (by burning the propellants through the orbital maneuvering system engines and the reaction control system engines). This dump is necessary to increase vehicle performance (by decreasing weight), to place the center of gravity in the proper place for vehicle control and to decrease the vehicle's landing weight. TAL is handled like a normal entry.

### **Abort to Orbit**

An ATO is an abort mode used to boost the orbiter to a safe orbital altitude when performance has been lost and it is impossible to reach the planned orbital altitude. If a space shuttle



main engine fails in a region that results in a main engine cutoff under speed, the Mission Control Center will determine that an abort mode is necessary and will inform the crew. The orbital maneuvering system engines would be used to place the orbiter in a circular orbit.

### **Abort Once Around**

The AOA abort mode is used in cases in which vehicle performance has been lost to such an extent that either it is impossible to achieve a viable orbit or not enough orbital maneuvering system propellant is available to accomplish the orbital maneuvering system thrusting maneuver to place the orbiter on orbit and the deorbit thrusting maneuver. In addition, an AOA is used in cases in which a major systems problem (cabin leak, loss of cooling) makes it necessary to land quickly. In the AOA abort mode, one orbital maneuvering system thrusting sequence is made to adjust the post-main engine cutoff orbit so a second orbital maneuvering system thrusting sequence will result in the vehicle deorbiting and landing at the AOA landing site (White Sands, N.M.; Edwards Air Force Base, Calif.; or the Kennedy Space Center, Fla). Thus, an AOA results in the orbiter circling the Earth once and landing about 90 minutes after liftoff.

After the deorbit thrusting sequence has been executed, the flight crew flies to a landing at the planned site much as it would for a nominal entry.

### **Contingency Aborts**

Contingency aborts are caused by loss of more than one main engine or failures in other systems. Loss of one main engine while another is stuck at a low thrust setting also may necessitate a contingency abort. Such an abort would maintain orbiter integrity for in-flight crew es-

cape if a landing cannot be achieved at a suitable landing field.

Contingency aborts due to system failures other than those involving the main engines would normally result in an intact recovery of vehicle and crew. Loss of more than one main engine may, depending on engine failure times, result in a safe runway landing. However, in most three-engine-out cases during ascent, the orbiter would have to be ditched. The inflight crew escape system would be used before ditching the orbiter.

### **Abort Decisions**

There is a definite order of preference for the various abort modes. The type of failure and the time of the failure determine which type of abort is selected. In cases where performance loss is the only factor, the preferred modes are ATO, AOA, TAL and RTLs, in that order. The mode chosen is the highest one that can be completed with the remaining vehicle performance.

In the case of some support system failures, such as cabin leaks or vehicle cooling problems, the preferred mode might be the one that will end the mission most quickly. In these cases, TAL or RTLs might be preferable to AOA or ATO. A contingency abort is never chosen if another abort option exists.

Mission Control Houston is prime for calling these aborts because it has a more precise knowledge of the orbiter's position than the crew can obtain from on-board systems. Before main engine cutoff, Mission Control makes periodic calls to the crew to tell them which abort mode is (or is not) available. If ground communications are lost, the flight crew has on-board methods, such as cue cards, dedicated displays and display information, to determine the abort region.



Which abort mode is selected depends on the cause and timing of the failure causing the abort and which mode is safest or improves mission success. If the problem is a space shuttle main engine failure, the flight crew and Mission Control Center select the best option available at the time a main engine fails.

If the problem is a system failure that jeopardizes the vehicle, the fastest abort mode that results in the earliest vehicle landing is chosen. RTLS and TAL are the quickest options (35 minutes), whereas an AOA requires about 90 minutes. Which of these is selected depends on the time of the failure with three good space shuttle main engines.

The flight crew selects the abort mode by positioning an abort mode switch and depressing an abort push button.

## **SHUTTLE ABORT HISTORY**

### **RSLS Abort History**

#### **(STS-41 D) June 26, 1984**

The countdown for the second launch attempt for Discovery's maiden flight ended at T-4 seconds when the orbiter's computers detected a sluggish valve in main engine No. 3. The main engine was replaced and Discovery was finally launched on Aug. 30, 1984.

#### **(STS-51 F) July 12, 1985**

The countdown for Challenger's launch was halted at T-3 seconds when on-board computers detected a problem with a coolant valve on main engine No. 2. The valve was replaced and Challenger was launched on July 29, 1985.

#### **(STS-55) March 22, 1993**

The countdown for Columbia's launch was halted by on-board computers at T-3 seconds following a problem with purge pressure readings in the oxidizer preburner on main engine No. 2. Columbia's three main engines were replaced on the launch pad, and the flight was rescheduled behind Discovery's launch on STS-56. Columbia finally launched on April 26, 1993.

#### **(STS-51) Aug. 12, 1993**

The countdown for Discovery's third launch attempt ended at the T-3 second mark when onboard computers detected the failure of one of four sensors in main engine No. 2 which monitor the flow of hydrogen fuel to the engine. All of Discovery's main engines were ordered replaced on the launch pad, delaying the shuttle's fourth launch attempt until Sept. 12, 1993.

#### **(STS-68) Aug. 18, 1994**

The countdown for Endeavour's first launch attempt ended 1.9 seconds before liftoff when on-board computers detected higher than acceptable readings in one channel of a sensor monitoring the discharge temperature of the high pressure oxidizer turbopump in main engine No. 3. A test firing of the engine at the Stennis Space Center in Mississippi on September 2nd confirmed that a slight drift in a fuel flow meter in the engine caused a slight increase in the turbopump's temperature. The test firing also confirmed a slightly slower start for main engine No. 3 during the pad abort, which could have contributed to the higher temperatures. After Endeavour was brought back to the Vehicle Assembly Building to be outfitted with three replacement engines, NASA managers set





Oct. 2 as the date for Endeavour's second launch attempt.

## **Abort to Orbit History**

### **(STS-51 F) July 29, 1985**

After an RSLS abort on July 12, 1985, Challenger was launched on July 29, 1985. Five minutes and 45 seconds after launch, a sensor problem resulted in the shutdown of center engine No. 1, resulting in a safe "abort to orbit" and successful completion of the mission.

## **SPACE SHUTTLE MAIN ENGINES**

Developed in the 1970s by NASA's Marshall Space Flight Center in Huntsville, Ala., the space shuttle main engine is the most advanced liquid-fueled rocket engine ever built. Every space shuttle main engine is tested and proven flight-worthy at NASA's Stennis Space Center in south Mississippi, before installation on an orbiter. Its main features include variable thrust, high performance reusability, high redundancy and a fully integrated engine controller.

The shuttle's three main engines are mounted on the orbiter aft fuselage in a triangular pattern. Spaced so that they are movable during launch, the engines are used—in conjunction with the solid rocket boosters—to steer the shuttle vehicle.

Each of these powerful main engines is 14 feet (4.2 meters) long, weighs about 7,000 pounds (3,150 kilograms) and is 7.5 feet (2.25 meters) in diameter at the end of its nozzle.

The engines operate for about 8½ minutes during liftoff and ascent—burning more than 500,000 gallons (1.9 million liters) of super-cold liquid hydrogen and liquid oxygen propellants

stored in the huge external tank attached to the underside of the shuttle. The engines shut down just before the shuttle, traveling at about 17,000 mph (28,000 kilometers per hour), reaches orbit.

The main engine operates at greater temperature extremes than any mechanical system in common use today. The fuel, liquefied hydrogen at -423 degrees Fahrenheit (-253 degrees Celsius), is the second coldest liquid on Earth. When it and the liquid oxygen are combusted, the temperature in the main combustion chamber is 6,000 degrees Fahrenheit (3,316 degrees Celsius), hotter than the boiling point of iron.

The main engines use a staged combustion cycle so that all propellants entering the engines are used to produce thrust or power—more efficiently than any previous rocket engine. In a staged combustion cycle, propellants are first burned partially at high pressure and relatively low temperature—then burned completely at high temperature and pressure in the main combustion chamber. The rapid mixing of the propellants under these conditions is so complete that 99 percent of the fuel is burned.

At normal operating level, the engines generate 490,847 pounds of thrust (measured in a vacuum). Full power is 512,900 pounds of thrust; minimum power is 316,100 pounds of thrust.

The engine can be throttled by varying the output of the pre-burners, thus varying the speed of the high-pressure turbopumps and, therefore, the flow of the propellant.

At about 26 seconds into launch, the main engines are throttled down to 316,000 pounds of thrust to keep the dynamic pressure on the vehicle below a specified level—about 580 pounds per square foot or max q. Then, the engines are throttled back up to normal operating level at



about 60 seconds. This reduces stress on the vehicle. The main engines are throttled down again at about seven minutes, 40 seconds into the mission to maintain three g's—three times the Earth's gravitational pull—again reducing stress on the crew and the vehicle. This acceleration level is about one-third the acceleration experienced on previous crewed space vehicles.

About 10 seconds before main engine cutoff or MECO, the cutoff sequence begins; about three seconds later the main engines are commanded to begin throttling at 10 percent thrust per second to 65 percent thrust. This is held for about 6.7 seconds, and the engines are shut down.

The engine performance has the highest thrust for its weight of any engine yet developed. In fact, one space shuttle main engine generates sufficient thrust to maintain the flight of 2½ 747 airplanes.

The space shuttle main engine is also the first rocket engine to use a built-in electronic digital controller, or computer. The controller will accept commands from the orbiter for engine start, change in throttle, shutdown, and monitor engine operation. In the event of a failure, the controller automatically corrects the problem or safely shuts down the engine.

NASA continues to increase the reliability and safety of shuttle flights through a series of enhancements to the space shuttle main engines. The engines were modified in 1988, 1995, 1998 and 2001. Modifications include new high-pressure fuel and oxidizer turbopumps that reduce maintenance and operating costs of the engine, a two-duct powerhead that reduces pressure and turbulence in the engine, and a single-coil heat exchanger that lowers the number of post flight inspections required. Another modification incorporates a large-throat main

combustion chamber that improves the engine's reliability by reducing pressure and temperature in the chamber.

After the orbiter lands, the engines are removed and returned to a processing facility at Kennedy Space Center, Fla., where they are rechecked and readied for the next flight. Some components are returned to the main engine's prime contractor, Pratt & Whitney RocketDyne, West Palm Beach, Fla., for regular maintenance. The main engines are designed to operate for 7.5 accumulated hours.

## **SPACE SHUTTLE SOLID ROCKET BOOSTERS**

The two SRBs provide the main thrust to lift the space shuttle off the pad and up to an altitude of about 150,000 feet, or 24 nautical miles (28 statute miles). In addition, the two SRBs carry the entire weight of the external tank and orbiter and transmit the weight load through their structure to the mobile launcher platform.

Each booster has a thrust (sea level) of about 3,300,000 pounds at launch. They are ignited after the three space shuttle main engines' thrust level is verified. The two SRBs provide 71.4 percent of the thrust at liftoff and during first-stage ascent. Seventy-five seconds after SRB separation, SRB apogee occurs at an altitude of about 220,000 feet, or 35 nautical miles (40 statute miles). SRB impact occurs in the ocean about 122 nautical miles (140 statute miles) downrange.

The SRBs are the largest solid-propellant motors ever flown and the first designed for reuse. Each is 149.16 feet long and 12.17 feet in diameter. Each SRB weighs about 1,300,000 pounds at launch. The propellant for each solid rocket



motor weighs about 1,100,000 pounds. The inert weight of each SRB is about 192,000 pounds.

Primary elements of each booster are the motor (including case, propellant, igniter and nozzle), structure, separation systems, operational flight instrumentation, recovery avionics, pyrotechnics, deceleration system, thrust vector control system and range safety destruct system.

Each booster is attached to the external tank at the SRB's aft frame by two lateral sway braces and a diagonal attachment. The forward end of each SRB is attached to the external tank at the forward end of the SRB's forward skirt. On the launch pad, each booster also is attached to the mobile launcher platform at the aft skirt by four bolts and nuts that are severed by small explosives at liftoff.

During the downtime following the Challenger accident, detailed structural analyses were performed on critical structural elements of the SRB. Analyses were primarily focused in areas where anomalies had been noted during post-flight inspection of recovered hardware.

One of the areas was the attach ring where the SRBs are connected to the external tank. Areas of distress were noted in some of the fasteners where the ring attaches to the SRB motor case. This situation was attributed to the high loads encountered during water impact. To correct the situation and ensure higher strength margins during ascent, the attach ring was redesigned to encircle the motor case completely (360 degrees).

Previously, the attach ring formed a C and encircled the motor case 270 degrees.

Additionally, special structural tests were done on the aft skirt. During this test program, an anomaly occurred in a critical weld between the

hold-down post and skin of the skirt. A redesign was implemented to add reinforcement brackets and fittings in the aft ring of the skirt.

These two modifications added about 450 pounds to the weight of each SRB.

The propellant mixture in each SRB motor consists of an ammonium perchlorate (oxidizer, 69.6 percent by weight), aluminum (fuel, 16 percent), iron oxide (a catalyst, 0.4 percent), a polymer (a binder that holds the mixture together, 12.04 percent), and an epoxy curing agent (1.96 percent). The propellant is an 11-point star-shaped perforation in the forward motor segment and a double-truncated-cone perforation in each of the aft segments and aft closure. This configuration provides high thrust at ignition and then reduces the thrust by about a third 50 seconds after liftoff to prevent overstressing the vehicle during maximum dynamic pressure.

The SRBs are used as matched pairs and each is made up of four solid rocket motor segments. The pairs are matched by loading each of the four motor segments in pairs from the same batches of propellant ingredients to minimize any thrust imbalance. The segmented-casing design assures maximum flexibility in fabrication and ease of transportation and handling. Each segment is shipped to the launch site on a heavy-duty rail car with a specially built cover.

The nozzle expansion ratio of each booster beginning with the STS-8 mission is 7-to-79. The nozzle is gimballed for thrust vector (direction) control. Each SRB has its own redundant auxiliary power units and hydraulic pumps. The all-axis gimbaling capability is 8 degrees. Each nozzle has a carbon cloth liner that erodes and chars during firing. The nozzle is a convergent-divergent, movable design in which an aft



pivot-point flexible bearing is the gimbal mechanism.

The cone-shaped aft skirt reacts the aft loads between the SRB and the mobile launcher platform. The four aft separation motors are mounted on the skirt. The aft section contains avionics, a thrust vector control system that consists of two auxiliary power units and hydraulic pumps, hydraulic systems and a nozzle extension jettison system.

The forward section of each booster contains avionics, a sequencer, forward separation motors, a nose cone separation system, drogue and main parachutes, a recovery beacon, a recovery light, a parachute camera on selected flights and a range safety system.

Each SRB has two integrated electronic assemblies, one forward and one aft. After burnout, the forward assembly initiates the release of the nose cap and frustum, a transition piece between the nose cone and solid rocket motor, and turns on the recovery aids. The aft assembly, mounted in the external tank/SRB attach ring, connects with the forward assembly and the orbiter avionics systems for SRB ignition commands and nozzle thrust vector control. Each integrated electronic assembly has a multiplexer/demultiplexer, which sends or receives more than one message, signal or unit of information on a single communication channel.

Eight booster separation motors (four in the nose frustum and four in the aft skirt) of each SRB thrust for 1.02 seconds at SRB separation from the external tank. Each solid rocket separation motor is 31.1 inches long and 12.8 inches in diameter.

Location aids are provided for each SRB, frustum/drogue chutes and main parachutes. These include a transmitter, antenna,

strobe/converter, battery and salt-water switch electronics. The location aids are designed for a minimum operating life of 72 hours and when refurbished are considered usable up to 20 times. The flashing light is an exception. It has an operating life of 280 hours. The battery is used only once.

The SRB nose caps and nozzle extensions are not recovered.

The recovery crew retrieves the SRBs, frustum/drogue chutes, and main parachutes. The nozzles are plugged, the solid rocket motors are dewatered, and the SRBs are towed back to the launch site. Each booster is removed from the water, and its components are disassembled and washed with fresh and deionized water to limit salt-water corrosion. The motor segments, igniter and nozzle are shipped back to ATK Thiokol for refurbishment.

Each SRB incorporates a range safety system that includes a battery power source, receiver/decoder, antennas and ordnance.

### **Hold-Down Posts**

Each solid rocket booster has four hold-down posts that fit into corresponding support posts on the mobile launcher platform. Hold-down bolts hold the SRB and launcher platform posts together. Each bolt has a nut at each end, but only the top nut is frangible. The top nut contains two NASA standard detonators (NSDs), which are ignited at solid rocket motor ignition commands.

When the two NSDs are ignited at each hold-down, the hold-down bolt travels downward because of the release of tension in the bolt (pre-tensioned before launch), NSD gas pressure and gravity. The bolt is stopped by the stud deceleration stand, which contains sand. The SRB



bolt is 28 inches long and 3.5 inches in diameter. The frangible nut is captured in a blast container.

The solid rocket motor ignition commands are issued by the orbiter's computers through the master events controllers to the hold-down pyrotechnic initiator controllers on the mobile launcher platform. They provide the ignition to the hold-down NSDs. The launch processing system monitors the SRB hold-down PICs for low voltage during the last 16 seconds before launch. PIC low voltage will initiate a launch hold.

### **SRB Ignition**

SRB ignition can occur only when a manual lock pin from each SRB safe and arm device has been removed. The ground crew removes the pin during prelaunch activities. At T minus five minutes, the SRB safe and arm device is rotated to the arm position. The solid rocket motor ignition commands are issued when the three SSMEs are at or above 90 percent rated thrust, no SSME fail and/or SRB ignition PIC low voltage is indicated and there are no holds from the LPS.

The solid rocket motor ignition commands are sent by the orbiter computers through the MECs to the safe and arm device NSDs in each SRB. A PIC single-channel capacitor discharge device controls the firing of each pyrotechnic device. Three signals must be present simultaneously for the PIC to generate the pyro firing output. These signals—arm, fire 1 and fire 2—originate in the orbiter general-purpose computers and are transmitted to the MECs. The MECs reformat them to 28-volt dc signals for the PICs. The arm signal charges the PIC capacitor to 40 volts dc (minimum of 20 volts dc).

The fire 2 commands cause the redundant NSDs to fire through a thin barrier seal down a flame tunnel. This ignites a pyro booster charge, which is retained in the safe and arm device behind a perforated plate. The booster charge ignites the propellant in the igniter initiator; and combustion products of this propellant ignite the solid rocket motor initiator, which fires down the length of the solid rocket motor igniting the solid rocket motor propellant.

The GPC launch sequence also controls certain critical main propulsion system valves and monitors the engine-ready indications from the SSMEs. The MPS start commands are issued by the on-board computers at T minus 6.6 seconds (staggered start—engine three, engine two, engine one—all about within 0.25 of a second), and the sequence monitors the thrust buildup of each engine. All three SSMEs must reach the required 90 percent thrust within three seconds; otherwise, an orderly shutdown is commanded and safing functions are initiated.

Normal thrust buildup to the required 90 percent thrust level will result in the SSMEs being commanded to the liftoff position at T minus three seconds as well as the fire 1 command being issued to arm the SRBs. At T minus three seconds, the vehicle base bending load modes are allowed to initialize (movement of 25.5 inches measured at the tip of the external tank, with movement towards the external tank).

At T minus zero, the two SRBs are ignited under command of the four on-board computers; separation of the four explosive bolts on each SRB is initiated (each bolt is 28 inches long and 3.5 inches in diameter); the two T-0 umbilicals (one on each side of the spacecraft) are retracted; the on-board master timing unit, event timer and mission event timers are started; the



three SSMEs are at 100 percent; and the ground launch sequence is terminated.

The solid rocket motor thrust profile is tailored to reduce thrust during the maximum dynamic pressure region.

### **Electrical Power Distribution**

Electrical power distribution in each SRB consists of orbiter-supplied main dc bus power to each SRB via SRB buses A, B and C. Orbiter main dc buses A, B and C supply main dc bus power to corresponding SRB buses A, B and C. In addition, orbiter main dc bus C supplies backup power to SRB buses A and B, and orbiter bus B supplies backup power to SRB bus C. This electrical power distribution arrangement allows all SRB buses to remain powered in the event one orbiter main bus fails.

The nominal dc voltage is 28 volts dc, with an upper limit of 32 volts dc and a lower limit of 24 volts dc.

### **Hydraulic Power Units**

There are two self-contained, independent HPUs on each SRB. Each HPU consists of an auxiliary power unit, fuel supply module, hydraulic pump, hydraulic reservoir and hydraulic fluid manifold assembly. The APUs are fueled by hydrazine and generate mechanical shaft power to a hydraulic pump that produces hydraulic pressure for the SRB hydraulic system. The two separate HPUs and two hydraulic systems are located on the aft end of each SRB between the SRB nozzle and aft skirt. The HPU components are mounted on the aft skirt between the rock and tilt actuators. The two systems operate from T minus 28 seconds until SRB separation from the orbiter and external tank. The two independent hydraulic systems are connected to the rock and tilt servoactuators.

The APU controller electronics are located in the SRB aft integrated electronic assemblies on the aft external tank attach rings.

The APUs and their fuel systems are isolated from each other. Each fuel supply module (tank) contains 22 pounds of hydrazine. The fuel tank is pressurized with gaseous nitrogen at 400 psi, which provides the force to expel (positive expulsion) the fuel from the tank to the fuel distribution line, maintaining a positive fuel supply to the APU throughout its operation.

The fuel isolation valve is opened at APU startup to allow fuel to flow to the APU fuel pump and control valves and then to the gas generator. The gas generator's catalytic action decomposes the fuel and creates a hot gas. It feeds the hot gas exhaust product to the APU two-stage gas turbine. Fuel flows primarily through the startup bypass line until the APU speed is such that the fuel pump outlet pressure is greater than the bypass line's. Then all the fuel is supplied to the fuel pump.

The APU turbine assembly provides mechanical power to the APU gearbox. The gearbox drives the APU fuel pump, hydraulic pump and lube oil pump. The APU lube oil pump lubricates the gearbox. The turbine exhaust of each APU flows over the exterior of the gas generator, cooling it, and is then directed overboard through an exhaust duct.

When the APU speed reaches 100 percent, the APU primary control valve closes, and the APU speed is controlled by the APU controller electronics. If the primary control valve logic fails to the open state, the secondary control valve assumes control of the APU at 112 percent speed.



Each HPU on an SRB is connected to both servoactuators on that SRB. One HPU serves as the primary hydraulic source for the servoactuator, and the other HPU serves as the secondary hydraulics for the servoactuator. Each servoactuator has a switching valve that allows the secondary hydraulics to power the actuator if the primary hydraulic pressure drops below 2,050 psi. A switch contact on the switching valve will close when the valve is in the secondary position. When the valve is closed, a signal is sent to the APU controller that inhibits the 100 percent APU speed control logic and enables the 112 percent APU speed control logic. The 100 percent APU speed enables one APU/HPU to supply sufficient operating hydraulic pressure to both servoactuators of that SRB.

The APU 100 percent speed corresponds to 72,000 rpm, 110 percent to 79,200 rpm, and 112 percent to 80,640 rpm.

The hydraulic pump speed is 3,600 rpm and supplies hydraulic pressure of 3,050, plus or minus 50, psi. A high-pressure relief valve provides overpressure protection to the hydraulic system and relieves at 3,750 psi.

The APUs/HPUs and hydraulic systems are reusable for 20 missions.

### **Thrust Vector Control**

Each SRB has two hydraulic gimbal servoactuators: one for rock and one for tilt. The servoactuators provide the force and control to gimbal the nozzle for thrust vector control.

The space shuttle ascent thrust vector control portion of the flight control system directs the thrust of the three shuttle main engines and the two SRB nozzles to control shuttle attitude and trajectory during liftoff and ascent. Commands

from the guidance system are transmitted to the ATVC drivers, which transmit signals proportional to the commands to each servoactuator of the main engines and SRBs. Four independent flight control system channels and four ATVC channels control six main engine and four SRB ATVC drivers, with each driver controlling one hydraulic port on each main and SRB servoactuator.

Each SRB servoactuator consists of four independent, two-stage servovalves that receive signals from the drivers. Each servovalve controls one power spool in each actuator, which positions an actuator ram and the nozzle to control the direction of thrust.

The four servovalves in each actuator provide a force-summed majority voting arrangement to position the power spool. With four identical commands to the four servovalves, the actuator force-sum action prevents a single erroneous command from affecting power ram motion. If the erroneous command persists for more than a predetermined time, differential pressure sensing activates a selector valve to isolate and remove the defective servovalve hydraulic pressure, permitting the remaining channels and servovalves to control the actuator ram spool.

Failure monitors are provided for each channel to indicate which channel has been bypassed. An isolation valve on each channel provides the capability of resetting a failed or bypassed channel.

Each actuator ram is equipped with transducers for position feedback to the thrust vector control system. Within each servoactuator ram is a splashdown load relief assembly to cushion the nozzle at water splashdown and prevent damage to the nozzle flexible bearing.



## **SRB Rate Gyro Assemblies**

Each SRB contains two RGAs, with each RGA containing one pitch and one yaw gyro. These provide an output proportional to angular rates about the pitch and yaw axes to the orbiter computers and guidance, navigation and control system during first-stage ascent flight in conjunction with the orbiter roll rate gyros until SRB separation. At SRB separation, a switchover is made from the SRB RGAs to the orbiter RGAs.

The SRB RGA rates pass through the orbiter flight aft multiplexers/demultiplexers to the orbiter GPCs. The RGA rates are then mid-value-selected in redundancy management to provide SRB pitch and yaw rates to the user software. The RGAs are designed for 20 missions.

## **SRB Separation**

SRB separation is initiated when the three solid rocket motor chamber pressure transducers are processed in the redundancy management middle value select and the head-end chamber pressure of both SRBs is less than or equal to 50 psi. A backup cue is the time elapsed from booster ignition.

The separation sequence is initiated, commanding the thrust vector control actuators to the null position and putting the main propulsion system into a second-stage configuration (0.8 second from sequence initialization), which ensures the thrust of each SRB is less than 100,000 pounds. Orbiter yaw attitude is held for four seconds, and SRB thrust drops to less than 60,000 pounds.

The SRBs separate from the external tank within 30 milliseconds of the ordnance firing command.

The forward attachment point consists of a ball (SRB) and socket (ET) held together by one bolt.

The bolt contains one NSD pressure cartridge at each end. The forward attachment point also carries the range safety system cross-strap wiring connecting each SRB RSS and the ET RSS with each other.

The aft attachment points consist of three separate struts: upper, diagonal and lower. Each strut contains one bolt with an NSD pressure cartridge at each end. The upper strut also carries the umbilical interface between its SRB and the external tank and on to the orbiter.

There are four booster separation motors on each end of each SRB. The BSMs separate the SRBs from the external tank. The solid rocket motors in each cluster of four are ignited by firing redundant NSD pressure cartridges into redundant confined detonating fuse manifolds.

The separation commands issued from the orbiter by the SRB separation sequence initiate the redundant NSD pressure cartridge in each bolt and ignite the BSMs to effect a clean separation.

## **SPACE SHUTTLE SUPER LIGHT WEIGHT TANK (SLWT)**

The super lightweight external tank (SLWT) made its first shuttle flight June 2, 1998, on mission STS-91. The SLWT is 7,500 pounds lighter than the standard external tank. The lighter weight tank allows the shuttle to deliver International Space Station elements (such as the service module) into the proper orbit.

The SLWT is the same size as the previous design. But the liquid hydrogen tank and the liquid oxygen tank are made of aluminum lithium, a lighter, stronger material than the metal alloy used for the shuttle's current tank. The tank's structural design has also been improved, making it 30 percent stronger and 5 percent less dense.



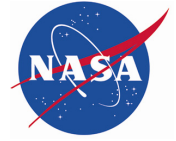

The SLWT, like the standard tank, is manufactured at Michoud Assembly, near New Orleans, by Lockheed Martin.

The 154-foot-long external tank is the largest single component of the space shuttle. It stands taller than a 15-story building and has a diame-

ter of about 27 feet. The external tank holds over 530,000 gallons of liquid hydrogen and liquid oxygen in two separate tanks. The hydrogen (fuel) and liquid oxygen (oxidizer) are used as propellants for the shuttle's three main engines.



This page intentionally left blank.



## ACRONYMS AND ABBREVIATIONS

AA	Antenna Assembly
AAA	Avionics Air Assembly
ABC	Audio Bus Coupler
AC	Assembly Complete
ACBM	Active Common Berthing Mechanism
ACO	Assembly and Checkout Officer
ACS	Atmosphere Control and Supply
ACSM	Attitude Control System Moding
ACU	Arm Computer Unit
ADO	Adaptation Data Overlay
ADSEP	Advanced Separation
ADVASC	Advanced Astroculture
ADVASC-GC	Advanced Astroculture—Growth Chamber
AEA	Antenna Electronics Assembly
AFD	Aft Flight Deck
AJIS	Alpha Joint Interface Structure
AKA	Active Keel Assembly
APAS	Androgynous Peripheral Attachment System
APCU	Assembly Power Converter Unit
APDS	Androgynous Peripheral Docking System
APFR	Articulating Portable Foot Restraint
APM	Attached Pressurized Module
APPCM	Arm Pitch Plane Change Mode
APS	Automated Payload Switch
AR	Atmosphere Revitalization
ARCU	American-to-Russian Converter Unit
ARIS	Active Rack Isolation System
ARS	Air Revitalization System
ASCR	Assured Safe Crew Return
ATA	Ammonia Tank Assembly
ATCS	Active Thermal Control System
ATU	Audio Terminal Unit
AUAI	Assemble Contingency System/UHF Audio Interface
AVU	Artificial Vision Unit
AVV	Accumulator Vent Valve
BA	Bearing Assembly
BBC	Bus Bolt Controller



BC	Bus Controller
BCDU	Battery Charge/Discharge Unit
BCU	Backup Controller Unit
BDU	Backup Drive Unit
BG	Beta Gimbal
BGA	Beta Gimbal Assembly
BGDS	Beta Gimbal Deployment Transition Structure
BGHS	Beta Gimbal Housing Subassembly
BIT	Built-In Test
BITE	Built-In Test Equipment
BMRRM	Bearing Motor and Roll Ring Module
BONEMAC	Bone Marrow Macrophages in Space
BPSMU	Battery Powered Speaker Microphone Unit
BRS	Bottom Right Side
BSP	Baseband Signal Processor
BTS	Bolt Tight Switch
C&C	Command and Control
C&DH	Command and Data Handling
C&M	Control and Monitor
C&T	Communication and Tracking
C&W	Caution and Warning
C/A-code	Coarse/Acquisition-code
C/L	Crew Lock
CA	Control Attitude
CAS	Common Attach System
CBM	Common Berthing Mechanism
CBOSS	Cellular Biotechnology Operating Science System
CCAA	Common Cabin Air Assembly
CCASE	Commercial Cassette Experiment
CCD	Cursor Control Device
CCMS	Concentric Cable Management System
CCS	Communication and Control System
CCTV	Closed-Circuit Television
CDDT	Common Display Development Team
CDRA	Carbon Dioxide Removal Assembly
CDS	Command and Data Software
CETA	Crew and Equipment Translation Aid
CEU	Control Electronics Unit
CFA	Circular Fan Assembly
CGBA	Commercial Generic Bioprocessing Apparatus
CHeCS	Crew Health Care System



CHX	Condensing Heat Exchanger
CID	Circuit Interrupt Device
CIOB	Cargo Integration and Operations Branch
CLA	Camera and Light Assembly
CLPA	Camera Light and Pan/Tilt Assembly
CMG	Control Moment Gyroscope
CMG-TA	Control Moment Gyroscope-Thruster Assist
CO <sub>2</sub>	Carbon Dioxide
COAS	Crew Optical Alignment Sight
COR	Communication Outage Recorder
COTS	Commercial-Off-The-Shelf
CP	Cold Plate
CPCG-H	Commercial Protein Crystal Growth-High
CR	Change Request
CRES	Corrosion Resistant Steel
CRIM	Commercial Refrigerator Incubator Module
CRIM-M	Commercial Refrigerator Incubator Module-Modified
CRPCM	Canadian Remote Power Controller Module
CSA	Computer Systems Architecture
CSA-CP	Compound Specific Analyzer-Combustion Products
CSCI	Computer Software Configuration Item
CSM	Cargo Systems Manual
CTB	Cargo Transfer Bag
CVIU	Common Video Interface Unit
CVT	Current Value Table
CVV	Carbon Dioxide Vent Valve
CWC	Contingency Water Collection
DAA	Docked Air-to-Air
DAG1	Docked A/G 1
DAIU	Docked Audio Interface Unit
DAP	Digital Autopilot
DC	Docking Compartment
dc	direct current
DCP	Display and Control Panel
DCSU	Direct Current Switching Unit
DDCU	DC-to-DC Converter Unit
DDCU-CP	DC-to-DC Converter Unit-Cold Plate
DDCU-E	External DDCU
DDCU-HP	DC-to-DC Converter Unit-Heat Pipe
DDCU-I	Internal DDCU
DFL	Data Format Load



DLA	Drive Locking Assembly
DMCU	Docking Mechanism Control Unit
DMS-R	Data Management System-Russian
dp/dt	delta pressure/delta time
DPA	Digital Preassembly
DPS	Data Processing System
DTO	Development Test Objective
DTV	Digital Television
E/L	Equipment Lock
E-Stop	Emergency Stop
EACP	EMU Audio Control Panel
EAIU	EMU Audio Interface Unit
EAS	Early Ammonia Servicer
EATCS	External Active Thermal Control Subsystem
ECLSS	Environmental Control and Life Support System
ECU	Electronics Control Unit
ED	Engagement Drive
EDDA	External Maneuvering Unit Don/Doff Assembly
EE	End Effector
EEATCS	Early External Active Thermal Control System
EET	Experiment Elapsed Time
EETCS	Early External Thermal Control System
EFGF	Electrical Flight-releasable Grapple Fixture
EGIL	Electrical Generation and Integrated Lighting Systems Engineer
EIA	Electrical Interface Assembly
EMPEV	Emergency Manual Pressure Equalization Value
EMU	Extravehicular Mobility Unit
EOA	EVA Ohmmeter Assembly
EPCE	Electrical Power Consuming Equipment
EPG	Electrical Power Generator
EPS	Electrical Power System
ER	Edge Router
ESA	External Sampling Adapter
ESP	External Stowage Platform
ESSMDM	Enhanced Space Station Multiplexer/Demultiplexer
ESU	End Stop Unit
ETCS	External Thermal Control System
ETI	Elapsed Time Indicator
ETRS	EVA Temporary Rail Stop
ETSD	EVA Tool Storage Device
ETVCG	External Television Cameras Group



EUE	Experiment Unique Equipment
EV	Extravehicular
EV-CPDS	Extravehicular-Charged Particle Directional Spectrometer
EVA	Extravehicular Activity
EVR	Extravehicular Robotics
EVSU	External Video Switching Unit
EXPRESS	EXpedite the PRocessing of Experiments to the Space Station
EXT	Experimental Terminal
EWIS	External Wireless Instrumentation System
FAWG	Flight Assignment Working Group
FC	Firmware Controller
FCC	Flat Controller Circuit
FCT	Flight Control Team
FCV	Flow Control Valve
FD	Flight Day
FDA	Fault Detection Annunciation
FDIR	Failure, Detection, Isolation and Recovery
FDS	Fire Detection and Suppression
FET	Field Effect Transistor
FGB	Functional Cargo Block
FHRC	Flex Hose Rotary Coupler
FI	Fault Isolator
FPU	Fluid Pumping Unit
FQDC	Fluid Quick Disconnect Coupling
FRD	Flight Requirements Document
FRGF	Flight Releasable Grapple Fixture
FSE	Flight Support Equipment
FSS	Fluid System Servicer
FWCI	Firmware Configuration Item
GAS	Get Away Special
GC	Growth Cell
GCA	Growth Cell Assembly
GFE	Government-Furnished Equipment
GFI	Ground Fault Interrupter
GJOP	Generic Joint Operations Panel
GLONASS	GLObal Navigational Satellite System
GN&C	Guidance, Navigation and Control
GNC	Guidance Navigation Computer
GPC	General Purpose Computer
GPRV	Gas Pressure regulating Valve



GPS	Global Positioning System
GUI	Graphical User Interface
H <sub>2</sub>	Hydrogen
HAB	Habitat Module
HC	Hand Controller
HCA	Hollow Cathode Assembly
HCOR	High-Rate Communication Outage Recorder
HDR	High Data Rate
HDRL	High Data Rate Link
HEPA	High Efficiency Particulate Air
HGA	High Gain Antenna
HHL	Handheld Lidar
HP	Heat Pipe
HPGT	High Pressure Gas Tank
HRF	Human Research Facility
HRF-PUF-DK	Human Research Facility Puff Data Kit
HRF-Res	Human Research Facility Resupply
HRFM	High Rate Frame Multiplexer
HRM	High Rate Modem
HRS	Hand Reaction Switch
I/F	Interface
I/O	Input/Output
IAC	Internal Audio Controller
IAS	Internal Audio Subsystem
IATCS	Internal Active Thermal Control System
ICC	Integrated Cargo Carrier
ICOM	Intercom
IDA	Integrated Diode Assembly
IDRD	Increment Definition Requirements Document
IEA	Integrated Equipment Assembly
IFHX	Interface Heat Exchanger
IFI	Item for Investigation
IFM	In-flight Maintenance
IMCA	Integrated Motor Control Assembly
IMCS	Integrated Mission Control System
IMU	Impedance Matching Unit
IMV	Intermodule Ventilation
INCO	Instrumentation and Communication Officer
INSTM	Instrumentation
INT	Internal





INTSYS	Internal Systems
IOC	Input/Output Controller
IOCU	Input/Output Controller Unit
IP	International Partner
IRU	In-Flight Refill Unit
ISA	Internal Sampling Adapter
ISIS	International Space Station Interface Standard
ISL	Integrated Station LAN
ISO	Inventory and Stowage Officer
ISPR	International Standard Payload Rack
ISS	International Space Station
ISSPO	International Space Station Program Office
ISSSH	International Space Station Systems Handbook
IT	Integrated Truss
ITCS	Internal Thermal Control System
ITS	Integrated Truss Segment
IUA	Interface Umbilical Assembly
IV	Intravehicular
IVA	Intravehicular Activity
IVSU	Internal Video Switch Unit
IWIS	Internal Wireless Instrumentation System
JAXA	Japan Aerospace Exploration Agency
JEM	Japanese Experiment Module
JEU	Joint Electronic Unit
KSC	Kennedy Space Center
kW	Kilowatt
LA	Launch Aft
Lab	Laboratory
LAN	Local Area Network
LB	Local Bus
LB-RWS	RWS Local Bus
LCA	Lab Cradle Assembly
LCC	Launch Commit Criteria
LCD	Liquid Crystal Display
LDI	Local Data Interface
LDR	Low Data Rate
LDU	Linear Drive Unit
LED	Light-Emitting Diode
LEE	Latching End Effector
LEU	LEE Electronic Unit



LFDP	Load Fault Detection Protection
LGA	Low Gain Antenna
LLA	Low Level Analog
LMC	Lightweight Multipurpose Carrier
LON	Launch On Need
LT	Low Temperature
LTA	Launch to Activation
LTL	Low Temperature Loop
LTU	Load Transfer Unit
LVLH	Local Vertical Local Horizontal
MA	Mechanical Assembly
MAM	Manual Augmented Role
MBE	Metal Bellows Expander
MBM	Manual Berthing Mechanism
MBS	Mobile Remote Service Base System
MBSU	Main Bus Switching Unit
MC	Midcourse Correction
MCA	Major Constituent Analyzer
MCAS	MBS Common Attach System
MCC	Mission Control Center
MCC-H	Mission Control Center-Houston
MCC-M	Mission Control Center-Moscow
MCDS	Multifunction CRT Display System
MCS	Motion Control System
MCU	MBS Computer Unit
MDA	Motor Drive Assembly
MDL	Middeck Locker
MDM	Multiplexer/Demultiplexer
MED OPS	Medical Operations
MEPS	Microencapsulation Electrostatic Processing System
MEPSI	Micro-Electromechanical System-based Pico Satellite Inspector
MER	Mission Evaluation Room
MET	Mission Elapsed Time
METOX	Metal Oxide
MFCV	Manual Flow Control Valve
MHS	MCU Host Software
MIL-STD	Military Standard
MILA	Mode Indicating Light Assembly
MIP	Mission Integration Plan
MISSE	Materials International Space Station Experiment
MLI	Multi-Layer Insulation



MM/OD	Micrometeoroid/Orbital Debris
MMT	Mission Management Team
MOD	Mission Operations Directorate
MPEV	Manual Pressure Equalization Valve
MPLM	Multipurpose Logistics Module
MPM	Manipulator Positioning Mechanism
MRL	Manipulator Retention Latch
MRS	Mobile Remote Servicer
MRSBS	Mobile Remote Servicer Base System
MSD	Mass Storage Device
MSFC	Marshall Space Flight Center
MSG	Microgravity Science Glovebox
MSS	Mobile Servicing System
MT	Mobile Transporter
MTCL	Mobile Transporter Capture Latch
MTL	Moderate Temperature Loop
MTS	Module-to-Truss Segment
MTSAS	Module-to-Truss Segment Attachment System
MTWsN	Move to Worksite Number
N <sub>2</sub>	Nitrogen
N. mi.	Nautical mile
NASA	National Aeronautics and Space Administration
NCC	Nominal Corrective Combination burn
NCG	Non Condensable Gas
NCS	Node Control Software
NCU	Network Control Unit
NET	No Earlier Than
NIA	Nitrogen Interface Assembly
NiH <sub>2</sub>	Nickel Hydrogen
NIV	Nitrogen Introduction Valve
NSI	NASA Standard Initiator
NSTS	National Space Transportation System
NTA	Nitrogen Tank Assembly
O <sub>2</sub>	Oxygen
OCA	Orbital Communications Adapter
OCAD	Operational Control Agreement Document
OCJM	Operator-Commanded Joint Position Mode
OCPM	Operator-Commanded POR Mode
OCS	Operations and Control Software
ODIN	Orbital Design Integration System

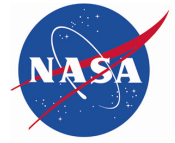

ODS	Orbiter Docking System
OI	Operational Increment
OIU	Orbiter Interface Unit
OIV	Oxygen Isolation Valve
OMI	On-Orbit Maintainable Item
OMS	Orbital Maneuvering System
OPCGA	Observable Protein Crystal Growth Apparatus
OPP	OSVS Patch Panel
Ops	Operations
OPS LAN	Operations Local Area Network
ORBT	Optimized RBar Targeting Technique
ORCA	Oxygen Recharge Compressor Assembly
ORU	Orbital Replacement Unit
OSE	Orbiter Support Equipment
OSO	Operations Support Officer
OSVS	Orbiter Space Vision System
OTD	ORU Transfer Device
OV	Orbiter Vehicle
P&S	Pointing and Support
P-code	Precision Code
P/L	Payload
P/TV	Photo/Television
P3/P4	Port 3/Port 4
PAS	Payload Attach System
PBA	Portable Breathing Apparatus
PC	Personal Computer
PCA	Pressure Control Assembly
PCAM	Protein Crystallization Apparatus for Microgravity
PCBM	Passive Common Berthing Mechanism
PCC	Power Converter Controller
PCG-STES	Protein Crystal Growth-Single Thermal Enclosure System
PCMCIA	Personal Computer Memory Card International Adapter
PCP	Pressure Control Panel
PCR	Portable Computer Receptacle
PCS	Portable Computer System
PCT	Post-Contact Thrusting
PCU	Plasma Connector Unit
PCVP	Pump and Control Valve Package
PDGF	Power and Data Grapple Fixture
PDI	Payload Data Interface
PDIP	Payload Data Interface Panel



PDRS	Payload Deployment and Retrieval System
PDTA	Power Data Transfer Assembly
PDU	Power Drive Unit
PEHG	Payload Ethernet Hub Gateway
PF	Payload Forward
PFCS	Pump Flow Control Subassembly
PFE	Portable Fire Extinguisher
PFMC	Pump/Fan Motor Controller
PFR	Portable Foot Restraint
PGBA-S	Plant Generic Bioprocessing Apparatus-Stowage
PGSC	Portable General Support Computer
PGT	Pistol Grip Tool
PHALCON	Power, Heating, Articulation, Lighting, and Control Officer
PJPAM	Pre-stored Joint Position Autosequence Mode
PLB	Payload Bay
PM	Pump Module
PMA	Pressurized Mating Adapter
PMCU	Power Management Control Unit
PMDIS	Perceptual Motor Deficits In Space
PMP	Payload Mounting Panel
POA	Payload/ORU Accommodation
POC	Portable Onboard Computer
POR	Point of Reference
POST	Power ON Self-Test
PP	Planning Period
PPA	Pump Package Assembly
PPAM	Pre-stored POR Autosequence Mode
ppO <sub>2</sub>	partial pressure of oxygen
PPRV	Positive Pressure Relief Valve
PPT	Precipitate
PRD	Payload Retention Device
PRLA	Payload Retention Latch Assembly
Prox-Ops	Proximity Operations
PSN	Power Source Node
PSP	Payload Signal Processor
PTB	Payload Training Buffer
PTCS	Passive Thermal Control System
PTR	Port Thermal Radiator
PTU	Pan/Tilt Unit
PV	Photovoltaic
PVCA	Photovoltaic Controller Application
PVCE	Photovoltaic Controller Element



PVCU	Photovoltaic Controller Unit
PVM	Photovoltaic Module
PVR	Photovoltaic Radiator
PVRGF	Photovoltaic Radiator Grapple Fixture
PVTCS	Photovoltaic Thermal Control System
PWP	Portable Work Platform
PWR	Portable Water Reservoir
PYR	Pitch Yaw Roll
QD	Quick Disconnect
R/F	Refrigerator/Freezer
R&R	Removal and Replacement
RACU	Russian-to-American Converter Unit
RAIU	Russian Audio Interface Unit
RAM	Random Access Memory
RAMV	Rheostat Air Mix Valve
RB	Radiator Beam
RBB	Right Blanket Box
RBI	Remote Bus Isolator
RBVM	Radiator Beam Valve
RCC	Reinforced Carbon-Carbon
RCS	Reaction Control System
RDA	Retainer Door Assembly
RF	Radio Frequency
RFCA	Rack Flow Control Assembly
RFG	Radio Frequency Group
RGA	Rate Gyro Assemblies
RHC	Rotational Hand Controller
RHX	Regenerative Heat Exchanger
RIC	Rack Interface Controller
RJMC	Rotary Joint Motor Controller
RMS	Remote Manipulator System
ROBO	Robotics Operations Support Officer
ROS	Russian Orbital Segment
RP	Receiver/Processor
RPC	Remote Power Controller
RPCM	Remote Power Controller Module
RPDA	Remote Power Distribution Assembly
RPM	Rbar Pitch Maneuver
RPOP	Rendezvous and Proximity Operations Program
RS	Russian Segment

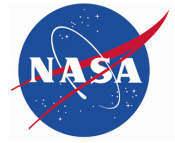

RSC	RMS Sideview Camera
RSP	Resupply Stowage Platform
RSR	Resupply Stowage Rack
RSTS	Rack Standalone Temperature Sensor
RSU	Roller Suspension Unit
	Remote Sensing Unit
RT	Remote Terminal
RT-Box	Reaction Time Box
RTAS	Rocketdyne Truss Attachment System
RTD	Resistive Thermal Device
RTL	Ready to Latch
RWS	Robotic Workstation
S	Starboard
S&M	Structures and Mechanisms
S3/S4	Starboard 3/Starboard 4
SA	Solar Array
SABB	Solar Array Blanket Box
SAGE	Space Arabidopsis Genomics Experiment
SARJ	Solar Alpha Rotary Joint
SARJ_C	SARJ Controller
SARJ_M	SARJ Manager
SASA	S-band Antenna Support Assembly
SAW	Solar Array Wing
SCA	Switchgear Controller Assembly
SCI	Signal Conditioning Interface
SCU	Service and Cooling Umbilical
SD	Smoke Detector
SDO	Solenoid Driver Output
SDS	Sample Delivery System
SEM	Shunt Electronics Module
SEPS	Secondary Electrical Power Subsystem
SFCA	System Flow Control Assembly
SFU	Squib Firing Unit
SGANT	Space-to-Ground Antenna
SHOSS	Spacehab Oceanering Space System
SHOT	Space Hardware Optimization Technology
SIGI	Space Integrated Global Positioning System/Inertial Navigation System
SJRM	Single Joint Rate Mode
SLDP	Spacelab Data Processing
SLP	Spacelab Logistics Pallet
SM	Service Module



SMCC	Shuttle Mission Control Center
SMDP	Service Module Debris Panel
SOC	State of Charge
SOV	Shutoff Valve
SPCE	Servicing Performance and Checkout Equipment
SPD	Spool Positioning Device
SPDA	Secondary Power Distribution Assembly
SPDM	Special Purpose Dexterous Manipulator
SPG	Single-Point Ground
SRMS	Shuttle Remote Manipulator System
SSAS	Segment-to-Segment Attach System
SSBA	Space Station Buffer Amplifier
SSC	Station Support Computer
SSMDM	Space Station Multiplexer/Demultiplexer
SSOR	Space-to-Space Orbiter Ratio
SSP	Standard Switch Panel
SSRMS	Space Station Remote Manipulator System
SSSH	Space Shuttle Systems Handbook
SSSR	Space-to-Space Station Radio
SSU	Sequential Shunt Unit
STCR	Starboard Thermal Control Radiator
STES	Single Thermal Enclosure System
STR	Starboard Thermal Radiator
SVS	Space Vision System
TA	Thruster Assist
TAA	Triaxial Accelerometer Assembly
TAH	Tray Actuation Handle
TBA	Trundle Bearing Assembly
TC	Terminal Computer
TCCS	Trace Contaminant Control Subassembly
TCCV	Temperature Control and Check Valve
TCS	Trajectory Control Sensor
TD	Translation Drive
TDRS	Tracking and Data Relay Satellite
TDRSS	Tracking and Data Relay Satellite System
TEA	Torque Equilibrium Attitude
TFR	Translation Foot Restraint
THC	Temperature and Humidity Control
THOR	Thermal Operations and Resources Officer
TI	Terminal Phase Initiation
TORF	Twice Orbital Rate Flyaround





TORU	Teleoperator Control Mode
TORVA	Twice Orbital Rate +Rbar to +Vbar Approach
TPL	Transfer Priority List
TRAC	Test of Reaction and Adaption Capabilities
TRC	Transmitter Receiver Controller
TRRJ	Thermal Radiator Rotary Joint
TSP	Twisted Shielded Pair
TTCR	Trailing Thermal Control Radiator
TUS	Trailing Umbilical System
TVIS	Treadmill Vibration Isolation System
TWMV	Three-Way Mixing Valve
UB	User Bus
UCCAS	Unpressurized Cargo Carrier Attach System
UDG	User Data Generation
UF	Utilization Flight
UHF	Ultrahigh Frequency
UIA	Umbilical Interface Assembly
ULCAS	Unpressurized Logistics Carrier Attach System
UIP	Utility Interface Panel
ULF	Utilization Logistics Flight
UMA	Umbilical Mechanism Assembly
UOP	Utility Outlet Panel
USA	United Space Alliance
USL	U.S. Laboratory
USOS	United States On-Orbit Segment
UTA	Utility Transfer Assembly
VAJ	Vacuum Access Jumper
VBSP	Video Baseband Signal Processor
VCP	Video Camera Port
VDS	Video Distribution System
VDU	Video Distribution Unit
VES	Vacuum Exhaust System
VGS	Video Graphics Software
VRCV	Vent/Relief Control Valve
VRIV	Vent/Relief Isolation Valve
VRS	VES Resource System
VRV	Vent/Relief Valve
VSC	Video Signal Converter
VSSA	Video Stanchion Support Assembly

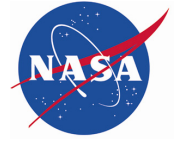

---

W/S	Worksite
WETA	WVS External Transceiver Assembly
WHS	Workstation Host Software
WIF	Worksite Interface
WRM	Water Recovery Management
WS	Water Separator
WVA	Water Vent Assembly
XPOP	X-axis Pointing Out of Plane
ZCG-SS	Zeolite Crystal Growth—Sample Stowage
ZSR	Zero-g Stowage Rack



## **MEDIA ASSISTANCE**

### **NASA TELEVISION TRANSMISSION**

NASA Television is carried on an MPEG-2 digital signal accessed via satellite AMC-6, at 72 degrees west longitude, transponder 17C, 4040 MHz, vertical polarization. For those in Alaska or Hawaii, NASA Television will be seen on AMC-7, at 137 degrees west longitude, transponder 18C, at 4060 MHz, horizontal polarization. In both instances, a Digital Video Broadcast (DVB)-compliant Integrated Receiver Decoder (IRD) (with modulation of QPSK/DBV, data rate of 36.86 and FEC  $\frac{3}{4}$ ) will be needed for reception. The NASA Television schedule and links to streaming video are available at:

<http://www.nasa.gov/ntv>

NASA TV's digital conversion will require members of the broadcast media to upgrade with an 'addressable' Integrated Receiver Decoder, or IRD, to participate in live news events and interviews, press briefings and receive NASA's Video File news feeds on a dedicated Media Services channel. NASA mission coverage will air on a digital NASA Public Services ("Free to Air") channel, for which only a basic IRD will be needed. The schedule for television transmissions from the orbiter and for mission briefings will be available during the mission at Kennedy Space Center, Fla.; Marshall Space Flight Center, Huntsville, Ala.; Dryden Flight Research Center, Edwards, Calif.; Johnson Space Center, Houston; and NASA Headquar-

ters, Washington. The television schedule will be updated to reflect changes dictated by mission operations.

### **Status Reports**

Status reports on countdown and mission progress, on-orbit activities and landing operations will be posted at:

<http://www.nasa.gov/shuttle>

This site also contains information on the crew and will be updated regularly with photos and video clips throughout the flight.

### **Briefings**

A mission press briefing schedule will be issued before launch. The updated NASA television schedule will indicate when mission briefings are planned.

### **Internet Information**

Information on safety enhancements made since the Columbia Accident is available at:

[www.nasa.gov/returntoflight/system/index.html](http://www.nasa.gov/returntoflight/system/index.html)

Information on other current NASA activities is available at:

<http://www.nasa.gov/home>

Resources for educators can be found at the following address:

<http://education.nasa.gov>

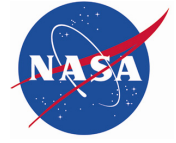

This page intentionally left blank.



## **PUBLIC AFFAIRS CONTACTS**

### **HEADQUARTERS WASHINGTON, DC**

Allard Beutel  
Public Affairs Officer  
Space Operations  
202-358-4769

Katherine Trinidad  
Public Affairs Officer  
Space Operations  
202-358-3749

John Yembrick  
Public Affairs Officer  
Space Operations  
202-358-0602

Michael Braukus  
Public Affairs Officer  
International Partners  
202-358-1979

### **JOHNSON SPACE CENTER HOUSTON, TEXAS**

James Hartsfield  
News Chief  
281-483-5111

Kyle Herring  
Public Affairs Specialist  
Space Shuttle Program Office  
281-483-5111

Kylie Clem  
Public Affairs Specialist  
Mission Operations and  
Flight Crew Operations  
281-483-5111

Rob Navias  
Program and Mission Operations Lead  
281-483-5111

Lynnette Madison  
Public Affairs Specialist  
International Space Station and Engineering  
281-483-5111

### **KENNEDY SPACE CENTER FLORIDA**

George Diller  
Public Affairs Specialist  
Space Shuttle  
321-867-2468

Tracy Young  
Public Affairs Specialist  
International Space Station  
321-867-2468

### **MARSHALL SPACE FLIGHT CENTER HUNTSVILLE, ALABAMA**

Dom Amatore  
Public Affairs Manager  
256-544-0034

June Malone  
Public Affairs Specialist  
Space Shuttle Propulsion  
256-544-0034

Steve Roy  
Public Affairs Specialist  
Space Shuttle Propulsion  
256-544-0034



## **STENNIS SPACE CENTER MISSISSIPPI**

Linda Theobald  
Public Affairs Specialist  
228-688-3249

Paul Foerman  
News Chief  
228-688-1880

Rebecca Strecker  
Public Affairs Specialist  
228-688-3346

## **AMES RESEARCH CENTER MOFFETT FIELD, CALIFORNIA**

Mike Mewhinney  
News Chief  
650-604-3937

Jonas Dino  
Public Affairs Specialist  
650-604-5612

## **DRYDEN FLIGHT RESEARCH CENTER CALIFORNIA**

Alan Brown  
News Chief  
661-276-2665

Leslie Williams  
Public Affairs Specialist  
661-276-3893

## **GLENN RESEARCH CENTER CLEVELAND, OHIO**

Lori Rachul  
News Chief  
216-433-8806

Katherine Martin  
Public Affairs Specialist  
216-433-2406

## **LANGLEY RESEARCH CENTER HAMPTON, VIRGINIA**

H. Keith Henry  
Deputy, Office of Public Affairs  
757-864-6120

## **UNITED SPACE ALLIANCE**

Mike Curie  
Space Program Operations Contract  
Houston Operations  
281-483-9251  
321-861-3805

Tracy Yates  
Florida Operations  
321-861-3956

## **BOEING**

Ed Memi  
Media Relations  
Boeing NASA Systems  
281-226-4029